

INTERNATIONAL SAMBO COMPETITION RULES (SPORTS AND COMBAT)

Approved by the XVII FIAS Congress Minutes
(November'2006, Sofia, Bulgaria)

In Sambo Competitions Rules (later Rules) the most important issues of officiating, competition organization and the work of officials are dealt with.

The edition is meant for coaches, officials, organizers and broad sections of athletes practicing Sambo.

The Rules are intended for obligatory direction in organization and conduct of Sambo competitions (sports and combat) starting from January 1, 2006.

Part 1. Character and Methods of Conducting Competitions

Article 1. Character of competitions

1. By its character the competitions are divided into:

- a) individual,
- b) team,
- c) individual-team,
- d) classification (Open mat).

2. The character of the competitions is defined by the Competition Regulations (later Regulations) set for a certain contest (see appendix 1).

3. In individual contests only individual results and the places of participants in their weight categories shall be defined.

4. In team competitions the teams meet each other and by the results of these meets the team places shall be defined.

5. In individual-team competitions individual places of participants shall be defined, the place of the team is defined depending on individual results of its contestants and in accordance with the Competition Regulations.

6. In classification competitions individual and team places are not defined, but the results are taken into consideration to improve or confirm the participants' sports qualification.

Article 2. Systems and Methods to Conduct Competitions

1. At the competitions the contestants compete in one group (system with no subgroups) or by means of a draw they are divided into several groups (system with subdivision into subgroups). In the last case the principle according to which the best contestants proceed to the next stage of competitions and the worst ones are eliminated should be explained additionally. In this case the competitions shall be divided into preliminary ones and finals.

2. Within every stage the competitions may be held according to one of the two methods:

- a) circular, when each contestant meets every other ones;
- b) with contestants' elimination after the number of defeats set by the Regulations.

3. The order of bouts among contestants (teams) shall be defined by the drawing of lots (a draw) and chosen system and method to conduct the competitions.

4. The system and the method to conduct preliminary and final parts of the competitions shall be stated by the Regulations.

5. Systems with different variations of combination methods to conduct the preliminary part and the finals are described, as well as the methods of conducting team competitions by the results of which the placing in team competitions is defined (see appendixes 2.1, 2.2; 3.1, 3.2; 4.1, 4.2, 4.3; 5; 6.1, 6.2, 6.3)

Part 2. Contestants

Article 3. Age groups

All the contestants shall be divided into the following age groups:

Groups	Men	Women
Younger children (Kids)	11 – 12 years old	11 – 12 years old
Schoolchildren	13 – 14 years old	13 – 14 years old
Cadets	15 – 16 years olds	15 – 16 years olds
Juniors	17 – 18 years old	17 – 18 years old
Youth	19 – 20 years old	19 – 20 years old
Seniors	19 and older	19 years older
Veterans 35-39, 40-44,	45-49, 50-54, 55-59,	60 and older

Article 4. Admission to the Competitions

1. The conditions of the contestants' admission to the competition, their sports membership, qualification and age, as well as the list of documents to be submitted to the Mandate Commission, shall be stipulated by the competition Regulations.

Participants of International Competitions included into the Calendar of the International Amateur Sambo Federation (FIAS) must possess the International competitor's license.

2. Entry lists from an organization for its members' participation shall be made in the prescribed form (appendix 7) with the compulsory, certified by stamps, signatures of the head of the organization, the coach and the doctor verifying the competitors' corresponding readiness. The date to submit preliminary entries is stated by the competition Regulations. The final entry to participate in competitions shall be submitted to the Mandate Commission by the team representative not later than 2 hours before the weigh-in starts.

3. Admission of competitors is accomplished by the Mandate Commission including a representative of the organization conducting the competitions, Chief official or his deputy, Chief Secretary, Chief Doctor and members of the commission who check entries and competitors' documents and their correspondence to the Regulation requirements. The representative of the host organization is responsible for competitors' admission in questionable situations.

4. Competitors' admission is accomplished in accordance with the given Regulations but it is permitted to admit to a certain age group the players who were born a year earlier.

5. Athletes who are of 17 years of age have the right to compete in senior groups.

Article 5. Weight Categories

Participants of competitions are distributed into the following weight categories:

Younger children and schoolchildren		Cadets		Juniors		Youth		Seniors		Veterans
Boys	Girls	Boys	Girls	Boys	Girls	Boys	Girls	Men	Women	Men
30	26	40	32	48	40	48	44	–	–	-
32	28	42	34	52	44	52	48	52	48	-
35	30	45	36	56	48	57	52	57	52	-
38	32	48	38	60	52	62	56	62	56	62
41	34	51	40	65	56	68	60	68	60	68
45	36	55	42	70	60	82	64	74	64	74
49	38	59	45	75	65	90	68	82	68	82
53	41	63	48	81	70	100	72	90	72	90

57	45	68	51	87	+75	+100	80	100	80	100
62	49	73	55	+87			+80	+100	+80	+100
67	53	78	59							
+67	+53	+78	+59							

In the junior and senior groups (men and women) the competitions for the Absolute Champion may be held without competitors' distribution into weight categories. Minimum weight in such competitions shall be stated in the Regulations.

Article 6. Weigh-in

1. The object of the weigh-in is to state the correspondence of competitors' weight to the limits of one of the weight categories. A competitor has the right to compete at the given competition only in the weight category stated for him at the weigh-in.

2. The order and time of the weigh-in shall be stated in the Regulations. A competitor who is late to the weigh-in or misses it is not admitted to the competitions.

During 1 hour before the start of the weigh-in contestants are allowed to get on the scales used for the official weigh-in as many times as they wish.

The weigh-in shall be held one time on the first day of competitions or a day before and shall last 1 hour. If the weigh-in is held on the day of the competitions it shall begin not less than 2 hours before the beginning of the competitions.

It is allowed to use several scales but competitors of a certain weight category shall be weighed on the same scales.

3. The weigh-in shall be held by officials' team appointed by the Chief official including a Chief official deputy (one of Mat chairmen), a representative of the competition secretariat, a doctor and two or three officials.

4. Before the weigh-in all the competitors shall undergo appearance medical control held by the competition doctor. Competitors shall be weighed in a special room or behind the screen, half-naked: men wearing athletic supporters, women-low-necked swimsuits.

5. At the weigh-in a competitor shall submit the document with a photo certifying his or her identity, competitor's license, insurance, medical control card and the filled in form.

6. Results of the weigh-in are entered in the score sheet (appendix 8) that shall be signed by all the members of the officials' team.

Article 7. Competitor's Duties and Rights

1. A competitor is obliged:

- a) to observe strictly the Rules, Program and competition Regulations;
- b) to obey officials' demands;
- c) to come forward to the mat immediately when called by the Board of Officials;
- d) to inform immediately the Board of Officials in case it is impossible because of any reason to continue the competition;
- e) to shake hands with the opponent before and after the bout;
- f) to be correct in relation to all competitors, officials, people who conduct and serve the competitions and spectators;
- g) to compete shaved or with a short beard of several months growth, nails closely cut, wearing a neat sports dress licensed by FIAS.

2. A participant has the right:

- a) to appeal to officials through the representative of his/her team; in the course of individual competitions (in case the representative is absent) to address the Chief official directly;
- b) 1 hour prior to the start of the weigh-in check the body weight on the official scales;
- c) in proper time to get the necessary information of the course of the competitions: the Program, changes in the Program if any, pairing for the next round, the results of the bouts, etc.;
- d) to use 2 minutes in the course of the bout to get medical aid.

Article 8. Dress

1. Competitor's dress consists of: the jacket, Sambo shoes and shorts. Besides, the male participants may wear a protective athletic supporter or non-metallic groin-guards and females – the bra and high-necked swimsuit.

The Sambo jacket shall be of red and blue color of special cut and the belt made of some cotton fabric.

The sleeve shall cover the arm up to the hand, the width of the sleeve shall make the clear space not less than 10 cm in between the arm and the sleeve along its length. On the line of the waist there shall be two holes at the distance of 5 cm, before and behind of the side seam, to run the belt through.

The belt shall be put through these holes twice and tightly embrace the body and tied in front by the knot, fastening together its both ends.

The ends of the tied belt shall not exceed 15 cm. The laps of the jacket shall be 20-25 cm lower than the waist line.

At all the official competitions only jackets with FIAS emblem (patent) are allowed to use.

Sambo shoes shall be made of soft leather with a soft sole and without any protruding stiff parts.

All the seams should be closed up inside.

Ankles and feet at the big toe joint shall be protected by small felt pads covered with leather.

Sambo shorts shall be made of woolen, half-woolen or synthetic jersey of red or blue color.

Their upper part shall reach the waist line and the lowest one shall cover one third of a hip.

2. Competitors shall appear for the Opening and Awarding ceremonies wearing the sports uniform of their team.

3. It is forbidden to wear during the bout rings, bracelets, ear rings, chains and other objects that might cause injury to the opponent.

Article 9. Team Representatives, Coaches and Captains

1. A Representative (head) of a certain team comes in between the Officiating Board and competitors. In case the team has no special representative its coach or captain shall fulfill his duties.

2. The representative is responsible for the discipline of his team competitors and ensures their presence at the competitions in time.

3. The representative shall participate in the drawing of lots, meetings of the Officiating Board if it is held jointly with them.

4. A representative has the right to submit to the Chief official a verbal and written protest (see article 37) grounded by the reference to the article and paragraph of the Rules.

5. Representatives, coaches and team captains are forbidden to interfere in the directions of officials and persons conducting competitions.

6. In the course of competitions a representative shall stay at a special place intended for representatives.

7. A representative (coach) can not act as an official at the given competitions.

8. For non-compliance with the duties a representative can be discharged from the leadership of the team.

9. In the course of the bout the coach (in a sports uniform) has to second the bout staying at a special place set for that near the mat, not leaving it during the bout and not interfering in the work of the officials.

Part 3. Officials

Article 10. Composition of the Officiating Board

1. The composition of the Officials Board is recommended by the corresponding Sambo Federation.

2. The officials shall consist of: Chief Officiating Board – Chief official, Chief official deputies, mat chairmen, Chief secretary ; referees, judges, timekeepers, secretaries, announcers,

officials attached to competitors; serving personnel – commentators, doctors, superintendent and others (calculation of the necessary number of officials and serving staff is given in appendix 9).

3. The officiating team for each bout shall consist of: 1 mat chairman, 1 referee, 1 judge, 1 timekeeper, 1 technical secretary and an informant (announcer).

4. The neutral officials' trio shall evaluate competitors' actions in the course of the bout: the mat chairman, the referee and the judge representing three different teams. Each of them evaluates the competitors' actions independently and while considering protests and questionable moments shall ground his actions by corresponding Regulations of the Rules.

5. An official shall have the official's uniform (costume), the official's card (certificate), the license, Rules of the competitions and the whistle.

The official's uniform (costume) shall consist of a white shirt with two-color sleeves (red right sleeve and blue left one), white trousers, socks and sports shoes approved by FIAS. On the left side of the chest there shall be the official's emblem of the corresponding category.

Article 11. The Chief Official

1. The Chief official directs the competitions and is responsible for their conduct in accordance with the present Rules and Regulations to the organization arranging the competitions and the corresponding Sambo federation.

2. The Chief Official is obliged:

a) to check the readiness of the venue for the competitions, the equipment and inventory outfit, their correspondence to the requirements of the present Rules, draw up a Statement of the venue acceptance (appendix 10) and also to be convinced that all the necessary documents are available;

b) to appoint officials for the weigh-in;

c) to hold the drawing of lots;

d) to approve the schedule of the competitions;

e) to distribute officials to the teams for separate mats;

f) to hold the meetings of the officials and team representatives before the start of the competitions (to announce the Rules and the officials' order of work) and every day after their end (to discuss the course of the competitions and results of the day) and also when it is necessary during the competitions;

g) to take all the measures to avoid or correct when necessary mistakes made by officials;

h) in proper time to make decisions on applications and protests submitted by team representatives (coaches, captains) in accordance with article 37;

i) to approve pairing off for the finals and appoint officiating teams to conduct them;

j) to evaluate the work of every member of the officials (taking in account his/her direct chief opinion) according to 5 point system;

k) within 3 days to submit the report (see appendix 11) to the organization conducting the competitions.

3. The Chief Official has the right:

a) to cancel competitions in case the venue or inventory outfit do not correspond to the Rules before their beginning;

b) to interrupt the bout, to make a break or to stop the competitions in case of unfavorable conditions preventing normal conduction of competitions;

c) to make changes in the Program and schedule of the competitions in case of the utmost necessity;

d) to change the officials functions in the course of the competitions;

e) to withdraw officials for gross errors or those who fail to fulfill their duties, marking it in the report and informing the Board of Officials of the corresponding Federation;

f) to declare a warning (or withdraw from carrying out their duties) to representatives, coaches and captains for rude behavior or arguments with the officials and those submitting groundless protests,

g) to delay the declaring of the technical action evaluation or the result of the bout if officials' opinions differ and in case he disagrees with their opinion, for additional discussion and final decision;

h) to declare the final decision on evaluation of the technical action or the result of the bout in a questionable situation if one of the three officials supports his decision;

i) to change the sequence of bouts in the finals if it becomes necessary.

4. The Chief Official has no right to change the competition Regulations and withdraw or change officials in the course of the bout.

5. It is obligatory for contestants, officials, team representatives and coaches to fulfill the Chief official's directions.

6. On the instructions of the Chief Official his functions at the competitions can be accomplished by his deputy or one of the mat chairmen.

Article 12. Chief Secretary

1. The Chief s Secretary directs the work of competition secretariat.

2. The Chief Secretary shall:

a) to be a part of Mandate Commission and officials' team at the weigh-in;

b) to take part in the drawing of lots;

c) to make up the Regulations and the schedule of the course of competitions;

d) to keep the score sheets of the competitions;

e) to make up the order of bouts in rounds;

g) to put the directions and decisions of the Chief official in order;

h) to submit to the Chief official's consideration the results of the competitions for approval and the necessary information for the account total;

i) to give information for representatives, commentators and correspondents if the Chief official approves;

3. To assist the Chief Secretary a deputy-one of the secretaries- is appointed.

Article 13. The Mat Chairman

1. The mat chairman shall be seated at the table while officiating at the bout and direct the work of the officiating team.

2. The mat chairman shall:

a) to compose the officiating teams for the bout with the Chief official's permission;

b) to call and introduce the participants of the bout and also announce its result (in case the commentator is absent);

c) to evaluate the contestants' actions and situations with the proper gestures (see appendix 12) and taking into account the opinion of the majority of votes declare the final decision;

d) when necessary or in case of a considerable disagreement of opinions among the three officials interrupt the bout and make the final decision after the additional discussion of the questionable situation;

e) after declaring the wrestler the second warning invite the Chief Official to the mat to discuss if the third warning should be declared.

Article 14. The Referee

1. The referee, while on the mat and using the means of officiating signaling (the whistle, terms and gestures according to the appendix 12), directs the course of the bout, evaluates the contestants' holds, actions and positions, follows the course of the bout and provides its proper conduct strictly according to the Rules.

2. The Referee shall:

a) take part in contestants' introduction,

b) blow the whistle to begin the bout and resume it after the breaks (if any) in Standing position in the middle of the mat.

c) interrupt the bout:

- if the players get in the "off mat" position (see article 33);

- if in the Ground position they are not active enough and don't display any real attempts to apply technical actions;
- if one of the contestants needs the medical assistance signaling it with the gesture "stop the time";
- if some disorder in a contestant's dress is found;
- if a contestant breaks the rules or is applying a prohibited hold and a caution or a warning shall be declared (except the case stated in p. 3 of the given article);
- at the request of the mat chairman;
- at the demand of the judge if the referee finds proper to do it at the given moment;
- at the request of the contestant if the referee finds it proper at the given moment;
- if he needs a consultation in the cases not foreseen by the Rules;
- d) stop the bout ahead of time:
 - at the submission signal of the contestant who is in the Ground position;
 - if two of the three officials evaluate the throw applied by the contestant as a Total Victory;
 - if one of the contestants displays Great Superiority in the bout;
 - in case of the decision to eliminate the contestant from the bout or his disqualification;
- e) blow the whistle by the gong signal to end the bout;
- f) take both contestants hands in the middle of the mat when the result is declared and raise the winner's arm.

3. If the defensive player in Ground position applies a prohibited hold, the referee without interrupting the bout demands to stop the application of a prohibited hold and declares a warning. In case the contestant disobeys, the referee shall interrupt the bout, declare the player the second warning for the application of the prohibited hold and by the Chief of the Officials decision eliminate him from the bout (see article 30, p. 1, a).

4. As soon as one of the contestants is taken for the hold-down the referee shall announce in a loud voice "Count Hold-down!" and make a proper gesture "hold-down". After 10 seconds he shall say in a loud voice "Ten seconds!", and after 20 seconds elapse he shall announce: "Hold-down is scored!" and with a corresponding gesture show the evaluation of it. If during the hold-down the defensive contestant assumes the position on his chest, stomach or buttocks when the angle between his back at the line of the shoulder-blades and the mat plane is more than 90 degrees, or he will push the opponent's body off his own, or both of them find themselves in the "Off Mat" position (see article 33) the referee shall announce "Escape!" and lower his arm.

If the top contestant switches from the hold-down to the painful hold the referee shall announce: "Out!"

5. As soon as one of the Sambo wrestlers starts to apply a painful hold the referee shall announce in a loud voice "Count the time!" and make a proper gesture. Since that moment 60 seconds are given to apply a painful hold. After this time elapses the referee shall interrupt the bout with his whistle announcing: "Not valid!" and resume the bout in the middle of the mat. If the attacker applying the painful hold, before the time elapses, switches to a hold-down or other technical actions in Ground position or if the defensive wrestler escapes from the painful hold and counter attacks, the count of the time for the painful hold is stopped but the bout is not interrupted.

In case one of the contestants starts a painful hold again 60 seconds are given anew.

Article 15. The Judge

1. The judge is positioned near the mat opposite the officials' table. If it is necessary, he may stand up from his seat and moving along the edge of the mat came closer to the contestants to see the situation better.

2. The judge evaluates contestants' actions independently signaling his evaluations with the proper gestures (see appendix 12).

3. In all the cases when to his opinion the bout shall be interrupted, the judge makes a proper gesture thus attracting the referee's attention and points out certain moments of the contest.

Article 16. The Timekeeper

1. The timekeeper shall sit at the mat chairman's table. He counts the time of the bout, hold-down and painful holds: after 2 minutes elapse he informs officials and contestants of the time of the bout, with the gong sound gives the signal of the end of the bout.

2. The timekeeper fixes by his stop-watch the contestant's delay to come to the mat after the first call and announces the time after the expiry of the first and every 30 seconds following.

3. With the interruption of the bout the timekeeper by the referee's whistle or by the mat chairman's indication stops his stop-watch and by the referee's whistle, starts it again counting actual time of the bout.

4. As soon as the referee during the bout announces "Count hold-down!" the timekeeper shall start his stop-watch and in every 5 seconds announce in a loud voice "Five!", "Ten!", "15!" and after the expiration of 20 seconds: "Time of hold-down!"

5. As soon as the referee during the bout announces: "Count the painful hold!" the timekeeper shall start his stop-watch and count the time announcing the time of the painful hold in every 10 seconds (besides 55 seconds). After the expiration of 60 seconds the timekeeper announces: "Time of the painful hold!"

Article 17. Technical Secretary, Informant, Commentator

1. The technical secretary shall sit at the mat chairman's table and in the course of the bout write down in the corresponding column of the score sheet (appendix 13) evaluations of technical actions and warnings declared by the mat chairman. After the end of the bout he writes down the sum of the points and the time of the bout and hands the score sheet to the mat chairman to define and declare the result of the bout and after that writes down this result in the score sheet.

2. Evaluations of holds in succession of their application by the contestants shall be entered in the score sheet with the figures 1, 2 or 4, activity – with the letter "A".

Evaluations for hold-downs shall be outlined by the circle. Recording of evaluations in the bout shall be done in such a way that it would be easy to define which one of the evaluations was the last. For instance, after the evaluation of every technical action, except the last one, the sign + (plus) is added.

Cautions are marked with letter "0". If the contestant was given the first (second) warning, 1(2) it is written down to his opponent.

Total victory is written down with the sign "X" with the explanation "throw" or "painful hold".

Elimination from the bout for the ordinary breaking the Rules according to the article 30, pp. 1, 2 is marked in the score sheet with the sign X. When the contestant is eliminated from the competitions in the course of the bout according to art. 30. pp. 3, 4., the sign X is used with the explanation "injury", or "breaking the Rules".

A contestant who does not come to the bout, is eliminated from the competitions. In front of his name depending on the reason it shall be written down "f/a" (failure to appear) or "med" (eliminated by the doctor) and to his opponent the result 4 : 0 with the time 0 min. 00 sec. is written down (0.00 – victory by the opponent's elimination from the bout).

If the bout ends ahead of time its actual time is fixed in the score sheet. On the left of the contestant's name the time spent for medical help, if any, shall be written down. While defining the result of the bout in corresponding columns the sum of technical points and the ones for the warnings to the opponent, accumulated by every contestant, and positive points in accordance with the table of article 25, are written down. The name of the winner is encircled, the name of the loser is crossed out.

It is forbidden to make other records in the score sheet.

3. The informant of the mat shows the evaluations of the contestants' actions in the bout on the scoreboard or a demonstration panel after the mat chairman announces them.

4. The commentator announces the Program and the order of conducting the competitions, introduces the participants of the regular bout, gives their sports description, clarifies certain regulations of the competition Rules and announces the result of every bout if the Chief Official permits. If the competitions are held in two premises simultaneously they shall be served by two commentators.

5. Depending on information equipment it is allowed to combine the work of the timekeeper and the informant or the technical secretary and the informant.

6. In case no commentator is available, with the Chief Official permission mat chairmen may introduce officiating teams of the mat, call to the mat and introduce the regular pair of contestants, announce the evaluations of the holds in the course of the bout and after its end - the result.

Article 18. The Official Attached to Contestants

The official **attached to** the contestants is obliged to:

a) before the start of the competitions check the presence of participants on the given day of the competitions and the correspondence of their dress to the requirements of the present Rules.

b) to acquaint the contestants with the Program and the schedule of the competitions' course;

c) to inform the players of the order of their coming forward to the mat;

d) to inform the Chief referee or the mat chairman if a contestant fails to step up to the mat or is eliminated from the competitions.

Article 19. The Doctor Of The Competitions

1. The doctor of the competitions shall be a member of the Officials' Board as the Chief official's deputy in the medical service and take part in its work.

2. The doctor of the competitions shall:

a) be a member of the commission that accepts the venue of the competitions;

b) check the entries and doctor's visa concerning the contestants' admission to the competitions;

c) be present at the weigh-in and carry out the medical control (external examination and the like) of the contestants;

d) check the observance of medical-hygienic requirements at the competitions venue;

e) carry out medical examination and observation of the participants in the course of the competitions;

f) provide the fighters with the medical service directly on the mat, make the decision whether or not a contestant is in the condition to continue the contest, inform the Chief official immediately and submit the corresponding information for the Secretariat;

g) after the end of the competitions submit the report of the medical provision of the competitions stating the cases of injuries and diseases if any (see appendix 14).

Article 20. Superintendent Of The Competitions

1. The superintendent of the competitions is responsible for the timely preparation and decorative design of the competition area, security, placing and service of participants and spectators, radio installation of the venue, maintenance of the order during the competitions and provide with all the necessary arrangements by the Chief referee's instructions.

2. The superintendent is responsible for the preparation and functioning of the special equipment and stock to conduct the competitions in accordance with the articles 38, 39.

Part 4. The Rules of Officiating

Article 21. The Contents of Sambo Contest

In the course of a Sambo contest it is permitted to apply throws, hold-downs, painful holds (Arm locks and Leg locks) and other attacking and defensive actions in definite positions of the contestants.

I. Contestants' Positions

1. Standing – such a position when the contestant touches the mat with his both feet only (is standing on his feet).

2. Ground – such a position when the contestant touches the mat with any part of the body except his feet.

In Ground position as well as while falling down after the throws or switching to Ground contest, the player can find himself:

a) on his back – in such a position when he touches the mat with his shoulder blades or rapidly (without stopping) rolls over on his back; “bridge” position when the contestant with his back to the mat touches it with his feet and the head only, is equal to the position “on the back”;

b) on a side – in such a position when the contestant touching the mat with one shoulder blade and his back at the shoulder level makes an angle up to 90^0 to the mat; a “half bridge” position when the contestant finds himself with his back to the mat and touches it with his feet, the head and a shoulder is equal to the “on a side” position;

c) on the chest or the stomach – in such a position when the contestant touches the mat with his chest or stomach and his back at the shoulder blades level makes an obtuse angle to the mat;

d) on the buttocks or the waist – in such a position when the contestant touches the mat with one (or two) buttock or with his small of the back (waist);

e) on the shoulder – in such a position when the contestant touches the mat with his shoulder joint or a shoulder pressed to his body;

f) on his knees (a knee) – in such a position when the contestant touches the mat with his knees (or a knee) and may sit on his calves without touching the surface of the mat with his buttocks;

g) on the hands (a hand) – in such a position when the contestant touches the surface of the mat with his hands or the forearms (a forearm).

3. Standing fight – both contestants are in “Standing” position.

4. Ground fight – one or both contestants are in “Ground position”.

II. Throws

1. A throw is such a contestant's action with the grip that makes his opponent lose the balance and fall down on the mat touching it with any part of the body except his feet, that is finds himself in one of the “Ground” positions. Counter throw is a throw when a defensive player responding to the opponent's attack seizes the initiative and applies the throw himself changing the character or the direction of the attacker's falling down.

2. Only the throws that are applied by the contestant from standing (before the opponent's falling down) shall be scored.

It is considered that the throw is applied by the attacker from standing position without falling down if during the throw (from its start to the very end) he keeps his “Standing” position. The throw is considered to be applied with the attacker's falling down when applying the throw he switches to one of the “Ground” positions or leans on his lying opponent to keep his balance. Any turns over as well as the throws applied by the contestant who is in “Ground” position are not evaluated.

3. Depending on the attacker's initial positions the following throws are distinguished:

a) throws of the opponent who is in standing position; of the same value are the throws when the attacker in the course of the throw shifts the opponent who is in one of “Ground” positions to Standing one or completely lifts him off the mat above his own waist and turns him over horizontal axis while throwing;

b) throws of the opponent who is on his knees or hands with his turning over horizontal axis; of the same value are the throws of the opponent who is in one of the “Ground” positions with his complete lift off the mat but lower than waist line and turning him over horizontal axis.

The opponent's lift off and dropping him to the same position without turning him over is not

scored. In any case the throws ending with the opponent's falling down on his hands are not evaluated.

III. Painful Holds (Arm locks and Leg locks)

1. A painful hold is considered when the opponent's arm or leg is locked in Ground position and it makes possible to apply the following actions: bend over (Lever), twisting a joint (Knot), pinching the tendons or the muscles (pinch) thus forcing the opponent to give up.

The start of the painful hold is considered after the attacker grips the opponent's extremities at a certain place to make him feel the pain or overcome his defensive hold. 60 sec. is given for these actions.

2. It is allowed to start the application of the painful hold when the defensive contestant is in "Ground" position; the attacker may stay in standing position.

3. The application of a painful hold shall be stopped if the defensive player assumes the "Standing" position and lifts the attacker's body (shoulders) off the mat.

4. The application of the painful hold on the leg shall be stopped as soon as the defensive fighter assumes the "Standing" position.

IV. Hold-down

1. A hold-down is a hold by means of which the attacker during a certain period of time forces his opponent to lie down on the mat on his back and presses his body with his own body weight (or presses the opponent's arms clasped to his body).

2. Counting out the time starts with the moment when the attacker presses his body (chest, side, back) to the opponent's body and fixes it in the position "on shoulder blades".

3. The hold-down ends when the player who was under the hold-down switches to positions "on the chest", "on the stomach" or "on the buttocks" (but not "on the waist") when the angle between his shoulder blades and the mat is over 90° , when he pushes the attacker up off his body or when the attacker switches to the painful hold.

Article 22. Start And End Of The Bout

1. Competitors are called to step up to the mat to conduct the bout.

2. Before the start of the bout the contestant who was called first (red dress) shall take his place in the red corner of the mat and his opponent (blue dress) – in the blue corner. After the introduction, by the referee's gesture they come to the middle of the mat and shake hands. Then they make a step back and by the referee's whistle start the bout.

3. The bout ends by the sound of the gong (sound signal) but not by the referee's whistle.

4. After the end of the bout the competitors return to their respective corners they occupied before the start of the bout. To declare the results the referee calls the players to the middle of the mat, takes both contestants' wrists, then lifts the winner's hand up (see appendix 15), after that the contestants shake hands and leave the mat.

Article 23. Course and Duration of the Bout

1. The duration of the bout shall be as follows:

- for seniors and juniors (men) – 5 minutes;
- for seniors over 60 years of age – 3 minutes;
- for seniors and juniors (women) – 4 minutes;
- for cadets, schoolchildren and kids (boys and girls) – 4 minutes;
- for veterans (men) – 4 minutes;
- for veterans (women) – 3 minutes.

2. Counting out the time of the bout begins at the first sound of the referee's whistle. The time of breaks is not included in the actual time of the bout.

In extreme situations it is allowed to include the time of breaks, not accompanied by the referee's gesture "Stop the time!", in the actual time of the bout (except semi-finals and finals) if it is stipulated in the Regulations of the competitions.

3. In the course of the bout the contestants shall not leave the mat without the referee's permission.

If it is necessary, the contestant may leave the mat with the referee's permission to put his dress in order.

4. In case of an injury the contestant is given not more than 2 minutes in the course of bout. The medical assistance is rendered directly on the mat (edge of the mat)

Article 24. The Number of the Bouts

1. In case the competitions last one day the number of bouts for seniors shall not exceed 9. If the competitions last over one day, the number of bouts per day shall not exceed 5. For juniors, cadets and schoolchildren the corresponding standards shall not exceed 7 bouts in one day competitions and 4 for those of many days.

2. The rest period in between the bouts shall not be less than 10 minutes for seniors and juniors and not less than 15 minutes for schoolchildren and youth.

Article 25. The Outcome and Evaluation of the Bout

1. The bout can result in the victory of one of the fighters and the defeat of the other or in the defeat of both contestants.

2. The victory can be (see the table of results and scoring in the bout):

- a) Total;
- b) by Superiority;
- c) on Points;
- d) Technical;
- e) on Warnings;
- f) by the opponent's elimination from the bout for passivity.

No.	Results of the bout	Classification points	
		winner	loser
1.	<u>TOTAL VICTORY</u> (ahead of time!)		
	a) Total throw	4	0
	b) painful hold;	4	0
	c) by Great Superiority	4	0
	(12 points and over difference)		
	d) the bout can't be continued (refusal, injury, time limit for medical help exceeded);	4	0
	e) opponent's disqualification for breaking the Rules	4	0
2.	<u>VICTORY BY SUPERIORITY</u>		
	(8-11 points advantage)		
	- the loser has got technical points;	3,5	0,5
	- the loser has no technical points	3,5	0
3.	<u>VICTORY ON POINTS</u>		
	(1-7 points advantage)		
	- the loser has got technical points;	3	1
	- the loser has no technical points;	3	0
4.	<u>TECHNICAL VICTORY</u>		
	a) under the equal number of points and the absence of "A" evaluations:		
	- by the number of technical points;		
	- the loser has got technical points;	3	1
	- the loser has no technical points;	3	0
	b) under the equal number of points and "A" evaluations:		

	- by the number of "A"	3	1 or 0
	- by the quality of technical points;	3	1
	- by the last technical evaluation;	3	1 or 0
	c) under only "A" evaluations:		
	- by the number of "A"	2	0
	- by the last "A".	2	0
5.	<u>VICTORY ON WARNINGS</u>		
	(with the absence of technical points and "A" evaluations and equal number of warnings):		
	- by the last evaluation declared to the opponent.	2	0
6.	ELIMINATION OF THE OPPONENT FOR PASSIVITY		
	(ahead of time!):	4	0
7.	ELIMINATION OF BOTH CONTESTANTS for passivity or DISQUALIFICATION OF BOTH CONTESTANTS for breaking the Rules (ahead of time!)	0	0

3. In case of contestant's elimination from the competitions by the doctor's decision directly before the bout or for being over 1,5 minute late for the bout, his opponent is scored 4:0 with the time 0,00 (victory by the opponent's elimination before the bout).

Article 26. Total Victory

1. Total victory is awarded:

- a) for the Total throw;
- b) for the painful hold;
- c) for Great Superiority of one of the contestants;
- d) for the opponent's elimination from the bout (according to art. 30, p. 1 a, b);
- e) for the opponent's elimination from the competitions in the course of the bout

(according to art. 30, pp. 3, 4 a, b, c).

2. Total throw is considered such a throw without the attacker's falling down as a result of which the defensive player from "Standing" position falls down on his back or rolls over his back rapidly (without stopping).

3. The painful hold is scored if one of the contestants gives a submission signal.

The submission signal is given in a loud voice "Yes!" or by clapping twice the mat or the opponent's body with the hand or foot.

Any exclamation from the contestant taken under the painful hold is considered to be a "give up" signal (except the case foreseen by art. 34, p. 2).

4. If in the course of the bout one of the contestants scores 12 (and over) points more than his opponent, the bout is stopped and the contestant is awarded the victory by Great Superiority.

5. With the Total victory the winner is scored 4 classification (positive) points, the loser gets 0.

Article 27. Victory By Superiority and On Points

1. If after the end of the bout one of the contestants has got 8 to 11 points of advantage this contestant is awarded the victory by Superiority. The winner gets 3,5 positive (classification) points.. The loser gets, or doesn't, 0,5 positive points depending on whether he has got or hasn't any technical points by the end of the bout.

2. If after the end of the bout one of the contestants has got 1 to 7 advantage points, he is awarded the victory on Points. In this case the winner may not have any technical points.

The winner gets 3 positive points, the loser gets 1 positive point if by the end of the bout he has got technical points or 0 if no technical points.

Article 28. Technical Victory

1. With no “A” evaluations in the bout and in case of the equal number of points (the tie) after its end, the victory goes to the contestant who has got more points for technical actions. The winner gets 3 positive points, the loser – 1 point if he has got any technical points by the end of the bout or 0 if no technical points.

2. With “A” evaluations in the bout in case of the tie after its end, the victory goes to the contestant who has got more “activities”.

If the contestants have got the equal number of activities, the victory is awarded to the one who has accumulated more points for technical actions, and in case of technical points tie - goes to the one who applied the holds of better quality (more holds evaluated as 4 and 2 points).

In case all the evaluations of both contestants are equal, the victory is awarded to the one who was the last to apply the evaluated hold in the course of the bout (1, 2, 4 points or “A”).

With the technical points the winner gets 3 and the loser 1 positive point if he has scored technical points by the end of the bout or 0 if he has not.

3. With evaluations “A” only and no points after the end of the bout the Technical victory goes to the contestant who has got more “activities” and in case of the tie – to the one who got the “A” evaluation last. In this case the winner gets 2 and the loser 0 positive points.

Article 29. Victory on Warnings

1. If by the end of the bout both contestants have not scored any technical points or “A” evaluation and have the equal number of warnings, the victory goes to the one who got the last evaluation for the warning declared to his opponent.

In this case the winner gets 2 positive points, the loser – 0.

Article 30. Elimination and Disqualification

1. The contestant is eliminated from the bout by the decision of the Chief official and his opponent is awarded the Total victory:

- a) at the second attempt to apply the prohibited hold;
- b) in case the contestant exceeds 2 minutes allowed for medical service intervention.

In this case the winner gets 4 positive points, the loser – 0. The bout is considered ended ahead of time and its time is stated in the score sheet.

2. The contestant is eliminated from the bout by the Chief official decision after two warnings when it is necessary to declare him the third warning for stalling if the three officials of the bout are of the united opinion or if the opinion of the officials’ majority is supported by the Chief official. In this case his opponent is awarded the victory ahead of time.

3. The contestant is eliminated from the competitions by the Chief Official if he can not continue the competition by the doctor’s decision because of some disease or an injury he got in the course of the bout. His opponent in this case gets 4 positive points and the eliminated one – 0 (in classification he takes the place in accordance with his result by the time he was eliminated).

4. The contestant is eliminated from the competitions by the Chief official (is disqualified):

- a) when he does not step up on the mat during 1,5 minute after the first call;
- b) for the rude and unethical behavior concerning his opponent, participants, officials and spectators, for the refusal to shake hands with the opponent or doing it tactlessly (incorrectly);
- c) for the application of a prohibited hold as a result of which his opponent gets an injury and by the doctor’s decision can not continue to compete;
- d) for the deception of officials.

In this case the eliminated contestant gets 0 positive points (in classification he gets neither individual, nor team placing). His opponent is scored 4 positive points.

Article 31. Evaluation of Holds

1. The holds of the attacker the application of which has brought him the Total victory, are evaluated by points. The quality and, respectively, the evaluation of the hold, depends on:

- * in what starting position the attacker was before the throw;
- * whether he applied the throw with or without falling down;
- * in what starting position the defensive fighter was before the throw;
- * on what part of the body he fell as a result of the opponent's throw.

2. 4 points are awarded:

- a) for the throw from Standing position with the attacker's falling down when his opponent falls on the back;
- b) for the throw from Standing position without the attacker's falling down when the opponent falls on his side;
- c) for 20 second hold-down.

3. 2 points are awarded:

- a) for the throw from Standing position with the attacker's falling down when the opponent falls on his side;
- b) for the throw from Standing position without the attacker's falling down when his opponent falls on the chest, stomach, buttocks, waist or shoulder;
- c) for the throw without falling down when the opponent, who was on his knees or hands before the throw, falls on the back;
- d) for over 10 second incomplete hold-down;
- e) for the second warning declared to his opponent.

4. 1 point is awarded:

- a) for the throw with falling down from Standing position when the opponent falls on his chest, stomach, buttocks, waist or shoulder;
- b) for the throw with falling down when the opponent, who was on his knees or hands before the throw, falls on his back;
- c) for the throw without falling down when the opponent, who was on his knees or hands before the throw, falls on his side;
- d) for the first warning declared to his opponent.

5. "Activity" ("A") is awarded:

- a) for the throw from Standing position without falling down when the opponent falls on his knee (knees);
- b) for less than 10 minute incomplete hold-down evaluated once in a bout.

The attacker falls down	Starting position of the defensive contestant			
	Standing		on his knees or hands	
	Attacker applies a throw from Standing position			
	without falling down	Without falling down	with falling down	with falling down
On the back	Total throw	4 points	2 points	1 point
On a side	4 points	2 points	1 point	—
On the chest, stomach, buttocks waist or a shoulder	2 points	1 point	—	—
On the knee (knees)	"A"	—	—	—

6. For the attacker's unsuccessful throw with his falling down on his buttocks, chest, stomach, waist, side or back, his opponent is not scored any points unless he counter-attacks. If the defensive fighter in his counter-attack could not change the character and direction of the

attacker's falling down and fell himself in the direction of his throw, the attacker's throw is considered applied.

7. Hold-down applied by the contestant in the course of one bout can't be evaluated over 4 points in the sum. That is why if a complete hold-down is applied all the points scored prior to that or "activity" for the incomplete hold-down are annulled. Besides, "activity" for the incomplete hold-down is annulled in case the evaluated as 2 points incomplete "hold-down" is applied.

8. When the bout is interrupted by the request of the contestant who is under the hold-down, his opponent in case he didn't break the Rules is scored as follows:

a) 4 points – if 20 seconds and over are left from the start of the hold-down to the end of the bout;

b) 2 points – if it is less than 20 seconds but over 10 sec left to the end of the bout;

c) Total Victory - if the wrestler taken under the hold-down gives the submission signal.

Article 32. Stalling (Passivity)

Stalling is considered to be:

a) intentional stepping off the mat in Standing position or crawling off in Ground position;

b) no real attempts to apply holds in Standing position;

c) imitation of attacks (false attack); to assume exclusively the defensive posture in Standing combat;

d) stalling from the holds in Standing position;

e) switching to Ground positions with no real attempts to apply a hold;

f) obvious pushing the opponent off the mat.

Article 33. Fight at the Edge of the Mat

1. "Off mat" position (beyond the edge of the mat) is considered to be if:

a) in Standing fight one of the contestants steps off the mat with his foot;

b) in Ground position one of the fighters is off the edge of the mat with the half of his body up to the waist line or shoulder blades and buttocks.

2. In the bout the "off mat" position is defined by the referee and in case of a dispute – by the majority of the three officials.

3. If the contestants find themselves in the "off mat" position, by the referee's whistle they shall return to the middle of the mat and resume the bout in Standing position. Without the referee's whistle a contestant shall not stop fighting at the edge of the mat and invite his opponent to the middle. The opponent has the right to apply a hold if there was no whistle.

4. The throw (counter-throw) started on the mat is also evaluated if it ends off the mat in protection zone. The throw started in the "off mat" position is not scored.

5. It is permitted to apply a hold-down or a painful hold started on the mat while one of the contestants contacts the central fighting zone of the mat.

Article 34. Prohibitions and Illegal Holds

1. In Sambo competitions it is prohibited:

a) to throw the opponent on the head, throw with the painful grip ("Knot", "Lever") and throw the opponent while falling down on him heavily with the whole body;

b) to apply strangle holds, squeeze the opponent's mouth and nose thus preventing his breathing;

c) to strike blows, scratch and bite;

d) to apply any painful holds on the spine, twist the neck, squeeze the opponent's head with the arms or legs or press it to the mat, cross the legs on the opponent's body;

e) to rest the hands (arms), legs or the head against opponent's face;

f) to press any part of opponent's body from above by the elbow or the knee;

g) to apply holds on opponent's fingers and toes;

h) to apply Arm Bar (bringing the opponent's arm behind his back); painful holds on hands;

- i) to twist the opponent's foot by the heel and apply "knots" on the foot;
- j) to apply "Lever" of the knee, overbending the leg contrary its natural bend;
- k) to apply painful holds in Standing position;
- l) to apply painful holds by jerks.

2. If officials do not notice the application of the illegal hold, the victim is allowed to give the signal in a voice or by the gesture.

The false signal is considered and penalized as an illegal hold.

3. The following actions are also prohibited:

* to grasp the opponent's shorts or the sleeve of the jacket from inside;

* to grasp the edge or the covering of the mat.

* to break deliberately the sports uniform by taking the arm from the sleeve of the jacket, roll up the jacket sleeves and so on.

Article 35. Cautions and Warnings

1. Violations of the Rules for which the contestant at fault can be declared a caution, a warning or can be eliminated from a bout or competitions are considered to be (see article 30):

a) appearing late to the mat;

b) application of the illegal hold;

c) rough fighting;

d) violation of discipline;

e) talking during the bout;

f) stalling and other prohibited actions;

g) leaving the mat without the referee's permission including the intervention of medical service;

h) representative's, coach's or other team mates' prompting alongside with unethical behavior near the mat (for violation of art. 9, pp. 5, 6).

2. The contestant can be declared only one caution in the course of the bout.

The referee has the right to give the contestant a caution without the agreement with other members of the officiating team.

3. For coming to the mat over 30 sec later after the first call the contestant is declared a caution, for being late for over 1 min – the first warning.

4. With the violations of the Rules stated in p.1 e, f, g. a caution is declared first, then a warning for the repeated breaking .

In the bout the first and second warnings are declared to the contestant (contestants) by the majority of the officiating team.

5. If a contestant, taken under a painful hold or the hold-down, has crawled off the mat, he is immediately declared the next penalty for the intentional fleeing the mat: the first, the second warning or elimination from the bout.

6. With the violations of the rules stated in 1, b, c, d the warning is declared without the preliminary caution.

7. In one bout the contestant can not be declared more than one warning for the application of an illegal hold. Every contestant can be declared only two warnings in one bout.

Article 36. Definition and Declaration of the Results of the Bout

1. Total victory is awarded:

a) if the contestant's technical action is evaluated as a Total throw by not less than two officials of the officiating team;

b) if the contestant successfully applies a painful hold.

2. The Victory by Great Superiority, Superiority, on Points or Technical is defined by the mat chairman in accordance with the records in a score sheet of the bout corresponding to the contestants' evaluations declared in the course of the bout.

3. A contestant (or both contestants) is eliminated from the bout by unanimous decision of the three officials or by the majority of voices with the permission of the Chief official (or his deputy).

Elimination from the bout or competitions is declared after the agreement with the Chief official (or his deputy).

4. The result is declared as follows:

a) Total victory by Great Superiority: “For... minutes... seconds by Total throw (painful hold, Great Superiority)... from... team won the bout (the winner’s and his team’s names);

b) if no Total victory: “... (the name) from the... (winner’s team) won the bout by Superiority (on Points);

c) if the contestant is eliminated from the bout: “For... minutes... seconds because of the opponent’s elimination the victory goes to... from... team (the name and the winner’s team);

d) if both contestants are eliminated from the bout or competitions: “Both contestants (players) are eliminated from the bout (competitions) and they are declared defeated with the time...minutes...seconds”.

Article 37. Protests

1. The protest may be submitted because of the rough violation of the Rules during the officiating of the bout or when unordinary situation occurs.

2. The procedure to submit a protest is as follows:

* verbal protest is submitted to the Chief official by the team representative directly in the course of the bout stating the article and point of the Rules that was violated;

* after the end of the bout the written protest shall be submitted;

* the protest concerning some unordinary situation (breaking of Regulations, order of weigh-in and pairing, misinformation on the part of the official persons, and so on) shall be submitted immediately after it happens in the written form, so that the Board of Officials will be able to make the decision with the minimum harm for the course and results of the competitions;

* the protest shall be accompanied by the sum of money set by FIAS (for national competitions – set by the National Sambo Federation).

3. Consideration of Protests

* in case the protest deals with the breaking of the Rules while officiating the bout it is considered by the Chief official and the three officials of the bout in question and also the representatives of the concerned parties (with no right to discuss the protest);

* considering the protest dealing with an unordinary situation, the persons involved in the violation of the Rules shall be present.

4. The decisions on the protest are taken:

* concerning the bout – immediately after the discussion by the Chief official, the bout is resumed after that;

* concerning other reasons – during the time that makes it possible to correct the mistakes with the minimum damage for the course and results of the competitions;

* the Chief Official makes the final decision and the persons involved shall be informed about it;

* in case the protest is upheld the accompanied sum of money shall be returned to the person submitted the protest.

Part 5. Competition Area

Article 38. The Mat

1. The size of the mat for Sambo competitions shall be from 11x11 up to 14x14 meters. The central surface (“working area”) of the mat where the bouts are conducted is the circle 6 to 9 meters in diameter. The width of the protective (safety) zone (the rest of the mat) shall not be less than 2,5 meters in any point of the circle. The mat, made of synthetic fabric, shall be smooth and not less than 5 centimeters thick.

If the mat is made of several smaller mats they shall be pushed together tightly and fastened firmly. There shall be no protuberances or hollows at the places of connection.

The centre of the mat is marked with the circle 1 meter in diameter, the width of bordering line shall make 10 centimeters.

The bounds of the mat (its central surface) shall be clearly marked by the line (or passivity zone). The width of the bounds shall make not less than 10 cm. This line (or zone) is a part of the “working” (central) surface of the mat.

2. The whole surface of the mat shall be covered with the coverlet made of firm soft fabric or some synthetic material without rough seams. The covering shall be tightly stretched and fastened.

Two opposite corners of the mat are marked with red and blue colors (red – to the left of the officials’ table, blue – to the right).

3. To prevent injuries the floor near the mat shall be covered with a soft material, carefully fixed in place (or gymnastics mats) with the width not less than 1 meter, not less than 5 centimeters thick and not thicker than the mat itself.

4. The platform where the mat is placed shall be up to 2,5 meters wider than the mat on every side.

To avoid any injuries at the distance of 2 meters around the mat there should be no strange objects. Spectators shall be seated at the distance of 3 meters from the mat.

5. During the competitions, held on the platform, its height shall not exceed 1 meter. The sides of the platform shall have 45⁰ outside incline.

6. The suitability of the mat and equipment for the competitions is defined by the Chief official, the doctor and representatives of the organization conducting the competition. The mat suitability is recorded in a special reception statement (appendix 10).

Article 39. Special Equipment and Inventory Outfit

1. The sound signal (gong) can be of any system but it shall sound loud enough.

2. The scales for the weigh-in shall be adjusted.

3. Stop-watches (electric stop-watches) shall have devices to stop and turn them off without disregarding minute and second indices before the end of the bout. To inform officials and contestants of every minute of expiration, the tables may be used.

4. To display the evaluation of the players' technical actions, the mat chairman and the judge may use color officiating signaling (discs with the handles) or Electro signaling.

5. To inform spectators and contestants of the course of the bout an electric score board or a simple shield is placed near the officials' table to display the points scored by the contestants. The left side of the shield is painted red, the right one - blue. The score tables shall have the figures 1,2,4 and letters "A" and "O" as well as 1,2,A,2,4 to display the evaluations for warnings and hold-downs. Figures and the text on the shield shall be well visible for spectators. It is admitted to display the sum of points of every contestant in the course of the bout but not separate points.

6. To inform the participants and representatives of the Program, schedule and the course of the competitions the information shield is installed. The shield size and construction is agreed beforehand with the secretariat of the competitions.

Article 40. Requirements for the Competition Venue

Coefficient of the natural light in the hall shall be not less than 1:6, with the artificial light - not less than 100 luxes. The mat should be lighted up from above by the lamps of reflecting or scattered light with the protective net.

The temperature in the venue of competitions shall be +15° to +25°C, humidity not less than 60%. Ventilation shall provide triple air exchange per hour.

In case the competitions are conducted in the open air (outdoors) the temperature shall be from +15 up to +25 degrees C. The mat shall be protected from direct sun rays.

PART 6. COMBAT SAMBO

Competitions in Combat Sambo are held in accordance with the given Rules and some additions:

Fighter's dress	Boxing helmet (red or blue). Gum shield. Groin guards. Combat Sambo gloves (hitting-gripping). Leg pads covering the front part of the shin and lacing of the Sambo shoes
-----------------	---

Article 41. Evaluations of the bout and technical actions

№	Evaluation of the holds	Evaluation of the actions
1.	Total (clear) victory (ahead of time)	a) knockout, two knockouts b) Total throw or the blow with the opponent's falling down on his back while the attacker keeps his standing position; c) the choke (strangle); d) painful hold e) evident (technical) superiority with 12 points or more (art.26); f) impossibility to continue the fight (bout, combat); g) disqualification for breaking the Rules (art.30).
2.	Four points evaluation ("4")	a) for a throw, the blow with the falling down from the standing position when the opponent falls on his back (art.31, p.2); b) for the throw, the blow on the side when the attacker keeps the standing position; (art.31, p.2); c) for complete hold-down during 20 sec (art.31, p.2); d) for the knockdown.
3.	Two points evaluation ("2")	a) for the throw, the blow (art.31,p.2); b) for the second warning declared to the opponent (art.31,p.3); c) for the incomplete hold-down over 10 sec but less than 20 sec (art.31, p.3).
4.	One point evaluation ("1")	a) for the throw, blow (art.31, p.4); b) for the first warning declared to the opponent (art.31, p.4);
5.	Activity	a) for the throw or blow without falling down from standing position when the opponent falls on his knee(knees);
6.	Caution	a) in accordance with Sambo Rules (art.31); b) for the passive defense of the defender lying on his stomach;
7.	Warning	a) in accordance with Sambo Rules (art. 31); b) for the repeated passive defense of the defender lying on his stomach.

KNOCKOUT – irreplaceable loss of the possibility to defend as a result of the missed blow: up to the count 10 the fighter can't come to consciousness and assume the fighting position.

Note: the athlete who got knockout on his head is eliminated from the competitions.

KNOCKDOWN – temporary loss of the possibility to defend as a result of the missed blow: up to the count 10 the fighter completely recovers consciousness and assumes the fighting position.

Note: with "knockdown" evaluation the position of the defender's body relative to the mat is also evaluated according to the Sambo Rules (art.26, 31) and the evaluation is summed up.

ARTICLE 42. LEGAL (ALLOWED) TECHNICAL ACTIONS

1. BLOW TECHNIQUES.

The blow is an impulsive technical action with the rectilinear or curvilinear trajectory executed by the arms, legs or the head to the parts of the body permitted by the Rules with the definite speed and strength.

The blows are evaluated if after applying the technical action the opponent completely lost his balance and fell down on a certain part of the body and is evaluated according to the Rules (art.26, 31).

- 1.1. Hand blows may be delivered by any part of the fist (except the base of the palm), with the elbow to the front and side part of the head, the trunk, arms and legs and also to the groin.
- 1.2. Leg blows are delivered with the knee, shin, foot, heel to the front or the side part of the head (except the oncoming blow with the knee when the opponent passes to the legs), the trunk, on the legs (the inner and outside part of the thigh or the shin) and to the groin.
- 1.3. Blows with the hands, legs and head in the ground position (except the back of the head, the neck and the rear part of the back, the loins, the coccyx and anus) are allowed if the attacker is also on the ground.

The ground position is defined according to the Sambo Rules.

Note:

- 1.3.1. Elbow blows are allowed except the oncoming blow to the head or collar bone when dragging the opponent by the opposite sleeve or the jacket lapel.
- 1.3.2. Blows to the head are delivered under the condition that the attacker and defender wear helmets.

2. THROWING TECHNIQUES

- 2.1. All kinds of throws applied in Sports Sambo are allowed (art.21, p.2).

3. GROUND TECHNIQUES

- 3.1. Painful holds in the ground position that are allowed in Sambo (art.21, p.3) and also painful holds in standing (Armlocks) including Arm Bar (“Police hold”) may be applied..

NOTE: During the application of a painful hold in case the defender resumes his standing position the bout is not stopped. In such a situation the defender may guard himself by throwing his opponent to the mat (except landing on the head).

- 3.2. STRANGLES (chokes) mean technical actions when the opponent’s neck is squeezed preventing his normal breath or making him faint. They are held both in standing and ground positions.

Strangles may be executed with the arms, legs and clothing.

Strangles with the arms are allowed only on the forearm of the attacked arm, not lead to the twisting of the neck part of the spine.

- 3.2.2. Strangles by the clothing are allowed only by the lapels of the Sambo jacket (except the belt).

- 3.2.3. Strangles with the legs are allowed only if the impact on the neck is made with the gripped arm of the defender.

- 3.3. HOLD-DOWNS – all that are permitted by the Rules.

ARTICLE 43. ILLEGAL TECHNICAL ACTIONS

- a) strike blows with the fingers and toes, open glove and the base of the palm;
- b) apply painful holds on the neck, spine, hand and foot;
- c) strike blows with the arms and legs from standing to the opponent in who is in ground position;

- d) strike blows on the neck, arm and leg joints (knee and foot arch) when fixing the attacked extremity in the direction against the natural flexion, the back of the head and spine, the loin, coccyx and annul hole, on the eyes with the fingers;
- e) strike blows on the head if one of the fighters has no helmet;
- f) throws forbidden in Sambo (art.34) and also throws with the hold of the neck;
- g) painful holds on muscles or joints forbidden in Sambo (art.34) with the exception of painful holds by arm bar and the situation of its application (that is the ones allowed in standing position);
- h) violation of discipline, rude unethical conduct toward the opponent, participants, officials or spectators.

Appendix 1

Competition Regulations

1. Regulations of competitions approved by the host organization, alongside with the Rules are the main documents the officials and contestants shall follow. In the opposite case the Official Board shall follow the Rules.

2. Paragraphs of the Regulations shall be exact and exclude their different interpretations.

3. The competition Regulations cover the following parts:

- object and tasks of the competitions;
- the venue and time of the given competitions;
- the organization that hosts the competitions;
- the Chief official and the Chief secretary (by name);
- contestants and teams (entry conditions for teams and participants, weight categories, age, classification, team and organization membership);
- the order and dates to submit entries, the list of documents to present for Mandate Commission;
- the order of medical control and medical-sanitary provision;
- the program of the competitions stating the days and time of the weigh-in and the bouts in every weight category;
- the character and method to conduct the preliminary and final parts of the competitions;
- duration of the bout;
- conditions of the competitions and scoring (definition of individual and team placing);
- system of results' evaluation;
- the order to submit re-entries and their consideration;
- the conditions for the contestants and team reception;

4. Only the organization that has approved the Regulations has the right to make alterations and enter additions to them but not later then the start of the draw and with the necessary information for the representatives of all the participating teams or all the participants.

Appendix 2.1

Circular System with the Subgroups Distribution

1. Order to conduct the competition.

1. If a great number of players takes part in the competition in one weight category it is permitted to distribute participants to 2, 4, 8 and 16 subgroups so the strongest participants shall find themselves in different subgroups. The rest of the competitors are distributed to subgroups by the draw.

2. While distributing competitors to two subgroups, to define individual placing the finals are held. From every subgroup two players taken the first and second places participate in the finals.

When distributing competitors to four subgroups, semi-finals are held among the ones taken the first and second places in the respective subgroups. The first group for semi-finals is composed of the winners of the first and second groups and the second semi-final group is made of the winners of the third and fourth subgroups. The competitors placed first and second in semi-final groups reach the finals.

This order is kept when distributing the competitors to eight or sixteen subgroups.

3. In the preliminary and final parts of the competitions competitors meet each other by the circular system and the bouts, held among the players who have reached semi-finals (or finals) from one subgroup, are considered semifinal (or final) and their results are recorded in score sheets of semifinal (final) competitions.

4. The wrestler who took the first place in the first semi-final subgroup is recorded in the final score sheet as number 1, the one placed the second in the first semifinal subgroup - as number 4; the one placed first in the second subgroup is recorded in the final score sheet as number 2; and the one placed second in the second semi-final group - as number 3.

This order is retained when recording score sheets of the intermediate stages of competitions (while distributing participants to 4,8, or 16 subgroups).

5. Participants who didn't enter the final or semifinal groups (or any other intermediate stage of the competitions) finish the competitions.

6. The competitions in the finals, semi-finals (or some other intermediate stage) are held in 2 rounds: the first round 1 - 3, 2 - 4; and the second round 1 - 2, 4 - 3. In the 2nd round of the finals it is permitted first to hold the bouts for the 3rd and 4th places and after that the bouts for the 1st and 2nd places may be held.

7. The given order is retained completely when team competitions are held by the circular system.

II. Order of Pairing Off.

1. In the subgroups to which the contestants are distributed at the start of the competitions there shall be not more than 6 players.

2. For pairing off in the 1st round the figures are written down according to the number of contestants in two columns: the first number - on the top of the left column, the second - on the top of the right one, and below them the ordinary numbers in succession – 3, 4, 5 and so on, are written down the quantity is equal to the half of all participants; the continuation is carried over to the left column by the order from the bottom to the top.

With the odd numbers of participants in subgroups after the last number "0" is added (to make the number of contestants even).

The opposite numbers meet each other.

3. To pair off the 2nd and the following rounds the numbers are displaced: the first number stays on its place, the rest are shifted anticlockwise to one place in every round that follows.

4. In every round in the subgroup with the odd number of participants one player is free (receives a bye that is meets with the 0).

5. The table bellow is made by the circular system:

the number of participants in subgroup	r o u n d s				
	1	2	3	4	5
3	1-2 0-3	1-3 2-0	1-0 3-2		
4	1-2 4-3	1-3 2-4	1-4 3-2		

5	1-2 0-3 5-4	1-3 2-4 0-5	1-4 3-5 2-0	1-5 4-0 3-2	1-0 5-2 4-3
6	1-2 6-3 5-4	1-3 2-4 6-5	1-4 3-5 2-6	1-5 4-6 3-2	1-6 5-2 4-3

III. Definition of Placing

1. In individual competitions a contestant who has got the greatest sum of positive points as a result of all the matches in the subgroup (in semifinals and finals) takes the 1st place in the group of participants at the given stage of the competitions. The places that follow are distributed in accordance with the reduction of positive points scored by the players.

2. If both players have the same number of total points, the winner of their mutual match takes the best place.

3. If several players have the same number of total points (the tie), the places are distributed by the greatest number of victories in the mutual meets.

4. With the equal sum of points and the same number of victories in mutual meets, the best place is defined by:

a) the greater number of positive points in their mutual meets;

b) quality of victories and defeats in the mutual meets; in this case the preference goes in succession to the contestant who has got:

- greater number of total victories 4:0;
- less time spent for these victories;
- greater number of victories 4:0 with the time 0.00 for the opponent's elimination before the bout because of his failure to appear on the mat or by the doctor's decision not scored as total victories;

- greater number of victories by Superiority 3,5:0;

- greater number of victories with the opponent's elimination 3,5:0;

- less time spent for these victories;

- greater number of victories by Superiority 3,5:0,5;

- greater number of victories on Points 3:0;

- greater number of victories for the opponent's elimination 3:0;

- less time spent for these victories;

- greater number of victories on Points 3:1;

- greater number of technical victories 3:0;

- greater number of technical victories 3:1;

- greater number of technical victories 2:0;

- greater number of points for the opponent's elimination 2:0;

- less time spent for these victories; and then to the one having scored in

succession:

- greater number of positive points in his defeats;

- less number of Total defeats 0:4;

- greater actual time in these bouts.

c) greater sum and better quality of technical points scored by the fighters in all mutual bouts;

d) the number of victories in all the bouts in the subgroup (in semi-finals and finals) and the quality of victories and defeats in accordance with p."b" of the given article;

Note: If a group of considered players, using one of these paragraphs can be distributed to subgroups, the places among the players within each group shall be allotted again applying pp.3,4 in succession;

e) if it is not possible to define among the contestants the best one according to the above given paragraphs, the draw is used when it is necessary to put one (or two) contestant into next stage of the competitions. In all other cases the players equally share the taken places.

5. Contestants who didn't reach the final or semifinal groups (or other intermediate stage of the competitions) finish the competitions and share the corresponding places:

a) if participants were distributed to two subgroups then those who took the 3-rd place in both subgroups share the 5th and 6th places, the ones who took the 4th place in subgroups share the 7th and 8th places, and so on;

b) in case participants were distributed to 4 subgroups the ones who took the 3-rd place and didn't reach the semi-finals, share 9-12th places; those who took the 4th place in subgroups share 13-16th places, and so on.

The analogous method is used to define the places with distribution to 8 and 16 groups.

6. If after the distribution to subgroups in one of them there is one contestant more, the player who took the last place in the given subgroup takes the last place in the weight category.

7. In case a contestant is eliminated from the competitions because of some disease after he held at least one bout in the subgroup, semi-finals or finals, he is placed considering that in all the bouts he missed he was defeated, and his opponent wins 4:0 with the time 0.00 (not scored as a total victory). If a contestant is eliminated by the doctor before his first bout, he is not defined any place.

8. For the contestant who was eliminated from the competitions by the Chief official decision the place is not defined and the results of his bout - be it in the subgroup, semi-finals or finals - are cancelled.

9. If in any weight category there is only one contestant it is considered that the championship in the given weight category is not played.

Appendix 2.2

Score Sheet of Sambo Competition Course

" ___ " _____ 200__
country _____

City,

Weight _____

Semifinal "A"

№	Name	Team	1	2	3	4	Points	Place
1			X					
2				X				
3					X			
4						X		

Finals

№	Name	Team	1	2	3	4	Points	Place
1			X					
2				X				
3					X			
4						X		

Semifinals "B"

№	Name	Team	1	2	3	4	Points	Place
1			X					
2				X				
3					X			
4						X		

Chief Official _____
Secretary _____

Chief

Appendix 3.1

Elimination System after Two Defeats

I. Order of the competition conduct.

1. In the course of the draw all the participants in every weight category get their numerical numbers in accordance with which they are distributed to two groups:
 - group "A" - players who got odd numbers (1, 3, 5 ...);
 - group " B" - players who got even numbers (2, 4, 6 ...).
2. The participant defeated twice in the preliminary part in the group is eliminated from the competitions. The elimination competitions last till the time when only 3 competitors stay in the group; they make group finals "A" and "B".
3. Group finals are held by the circular system. The results of the mutual meets held are taken into consideration and all the missing meets are conducted. By the results of all mutual bouts the places of the three best players in each group are defined: A1, A2, A3, and B1, B2, B3.
4. Final bouts can be held by two methods:
 - a) A1 - B1 for the 1st place,
A2 - B2 for the 3rd place,
A3 - B3 for the 5th place.
 - b) A1 - B1 for the 1st place,
A2 - B3 for the 3rd place,
A3 - B2 for the 3rd place.
5. If after the next round 2 contestants remain in the group, they take the 1st and 2nd places in the group by the result of the bout between them, and the 3rd place goes to the best one among those eliminated from this group in the last round.
If after the next round only 1 contestant remains in the group he takes the 1st place, the 2nd and 3rd places go to the two best among the contestants eliminated from this group in the last round by the result of the meet between them, it shall be held if they haven't yet met. If after the next round all the contestants were eliminated then the 3 best of them eliminated in the last round will make the group finals.

II. Order of Pairing Off.

1. Pairing off begins with drawing up the list of all participants of the round.
The list of the participants of the 1-st round means the list of the group according to numerical order increase in the course of the competitions in previous rounds. Besides, the contestant who was a bye (free) in the given round (with the odd number of contestants in it) will go to the top of the list of this round, and pairing off for the next rounds will start with him until another "bye" takes place at the top of the round list in his turn.
2. The contestant who received a bye in the given round will go to the following round without the bout. The order of fixing a bye is from the bottom to the top according to the list of participants in the given round starting with the last one.
3. When pairing off for the subsequent round, the "top" one in the round list meets with the nearest "bottom" one with whom he hasn't yet met.
For instance, for 5 participants in the group A the list of the 1st round will make: "1, 3, 5, 7, 9" and pairings of the 1st round: 1 - 3, 5 - 7, 9 - bye. The list of the 2nd round will make: "9, 1, 3, 5, 7" and the pairings: 9 - 1, 3 - 5, 7 - bye.

If a contestant "3" is eliminated in the 2nd round, the list of the 3-rd round will make: "7, 9, 1, 5" and so on.

4. If in the last pair the contestants have already met, one more pair, last but one, is added and of these 4 participants two new pairs are made up.

In this case the top one shall be paired off with all the bottom ones in turn with whom he has not yet met until in another pair there will be found participants who had not met before.

If the aim is not gained, one more pair is added and of 6 participants 3 new pairs are made up according to the same principle and so on.

5. If by successive use of p.4 the aim is not gained, then in the given round another participant next in turn shall draw a bye.

After that the pairing off in this round is made anew (using p.4 if necessary) , and so on.

6. The broken sequence of byes is restored in the following round and the participant who gets a bye according p.5 is considered having used his right to be free (get a bye) next time.

7. In the last rounds of the preliminary part of the competitions, it may happen that a contestant receives a bye for the second time in the row or two contestants get a bye.

In any case the number of pairs in the round shall be the maximum.

III. Definition of Contestants' Placing

1. Places 1 to 6 are defined by the results of the final bouts.

2. With the placing of contestants who did not reach the finals, the participant is considered the best if he has got in succession:

- greater number of rounds before his elimination (including the round when he had a bye);
- greater sum of positive points for all the bouts in the group;
- greater number of victories in mutual meets if they were held, and better quality of victories and defeats (appendix 2.1, part III,pp. 3, 4, a, b, c);
- greater number and better quality of victories and defeats in all the bouts in the group.

Participants having the equal indices at this stage share the respective places.

3. The participant is considered the best in the group in the last round among the ones who were eliminated if he has got:

- greater number of positive points in all the bouts in the group; the victory in the mutual meet that shall be held if there was none.

4. With the placing in the group finals, the best participant is considered to be the one who has got:

- greater number of positive points in all the bouts in the group finals;
- greater number of victories and better quality of victories and defeats in the group finals;
- less time spent for total victories;
- greater number and better quality of Technical points in the bouts of the group finals;
- less number of warnings in the bouts of the group finals;
- greater number of positive points scored for all the competitions;
- less time spent for Total victories in all the bouts;

In this case if the index, used to compare the players, is of the different meaning for all the three of them, these 3 places are defined by this index. If only the best (or the worst) player can be defined by this index, the places in the group finals of the other two players with the equal index are defined by the result of their mutual meet.

If all the indices of the three players are the same, the best one in the group finals is defined by a draw.

5. If a contestant is eliminated from the competitions by the doctor, he takes the place in accordance with the elimination round and the result he has got by that time. In case he

has reached the group finals, he is included in pairing off at this stage and in the list of final pairs, he is scored in the rest of the bouts the defeat 0:4 with the time 0.00 and his placing is defined by this result.

6. If a contestant is eliminated from the competitions by the Chief official decision (failure to come to the mat, rough breaking of the Rules) his placing is not defined. In case it happened in the finals of the competitions his opponents are scored the victory 4:0 with the time 0.00 and they are placed in the finals according to these results. Participants who didn't reach the finals go one place up.

Appendix 3.2

Score Sheet of Sambo Competition Course

" ___ " _____ 200__ City, country _____
Weight _____

Participant No.	Name	Team, sports rating	Meets by rounds								Elimination round	Positive points	Placing
			1	2	3	4	5	6	...	Semifinals			
1													
3													
5													
...													
2													
4													
6													
...													

Chief Official _____

Chief Secretary _____

Appendix 4.1

System of Distribution to Groups, Elimination and Repecharges (loser's pool).

1. Order to conduct the competition..

All the participants are distributed to two groups at the draw: A (odd) and B (even). Numerical order of every player is defined by the draw directly at the weigh-in or after it ends and is kept for him during the whole time of the competition.

1. In groups A and B the participants scoring victories in preliminary bouts, proceed to the following round. Thus it lasts until two finalists are defined - the strongest ones in the groups (A1 and B1).

2. Among the contestants defeated by the strongest players, repecharges (loser's pool, consolation bouts) are held by the scheme of the appendix 4.2, for the definition of the following places in the groups (A2, A3 and B2, B3).

3. Another version of repecharges is shown in the scheme of the appendix 4.3, according to which the players who lost to 4 semifinalists and the defeated semi-finalists take part in them.

4. With the great number of participants repecharges of the round may not be held (the so-called "Olympic" system).

5. The version of holding the bouts - according to pp. 3, 4 or 5 - shall be stated in the competition Regulations.

6. In the finals the meets for the 1st and also for the 3rd and 5th places are held. The matches for the 3rd or the 5th places are not held if it is stipulated in the Regulations.

II. Order of Pairing Off and Definition of Places.

1. The pairs of the first and all the following rounds in the preliminary competitions are made up according to the scheme of the appendices 4.2 and 4.3.

2. In case repechages are held by p.3 part I, the loser to the strongest player in the 1st round meets with the loser to the strongest one in the 2nd round. Then the winner of this bout wrestles with the player defeated by the strongest contestant in the 3rd round and so on. In the finals the winners of repechages (A2 and B2) compete for the 3rd place, the losers of the last repechage - for the 5th place.

3. When conducting repechages by p.4 part I, the losers to semi-finalists in the 1st round meet with the losers to the same semi-finalists in the 2nd round, the winners of these bouts meet with the losers to the same semi-finalists in the 3rd round, and so on.

The winners of these meets competed in one group draw the right to meet the defeated semi-finalists of another group. The winners of these bouts (A2 and B2) compete in the finals for the 3rd place, the losers of the last repechage bout (A3 and B3) - for the 5th place.

4. In the finals for the 1st place, the players who haven't lost a single bout meet in their group (A1 and B1).

5. Following the players who took the 5th - 6th places, the ones who lost last but one repechage bout, take the 7th - 8th places, and so on.

6. After that the places are defined for the players who did not get into the repechages, depending on the round they finished the competitions in. The ones eliminated in one round share the respective place.

**Score Sheet
of Sambo Competiton Course**

« _____ » 20__ г. City, country. _____

Weight _____ kg

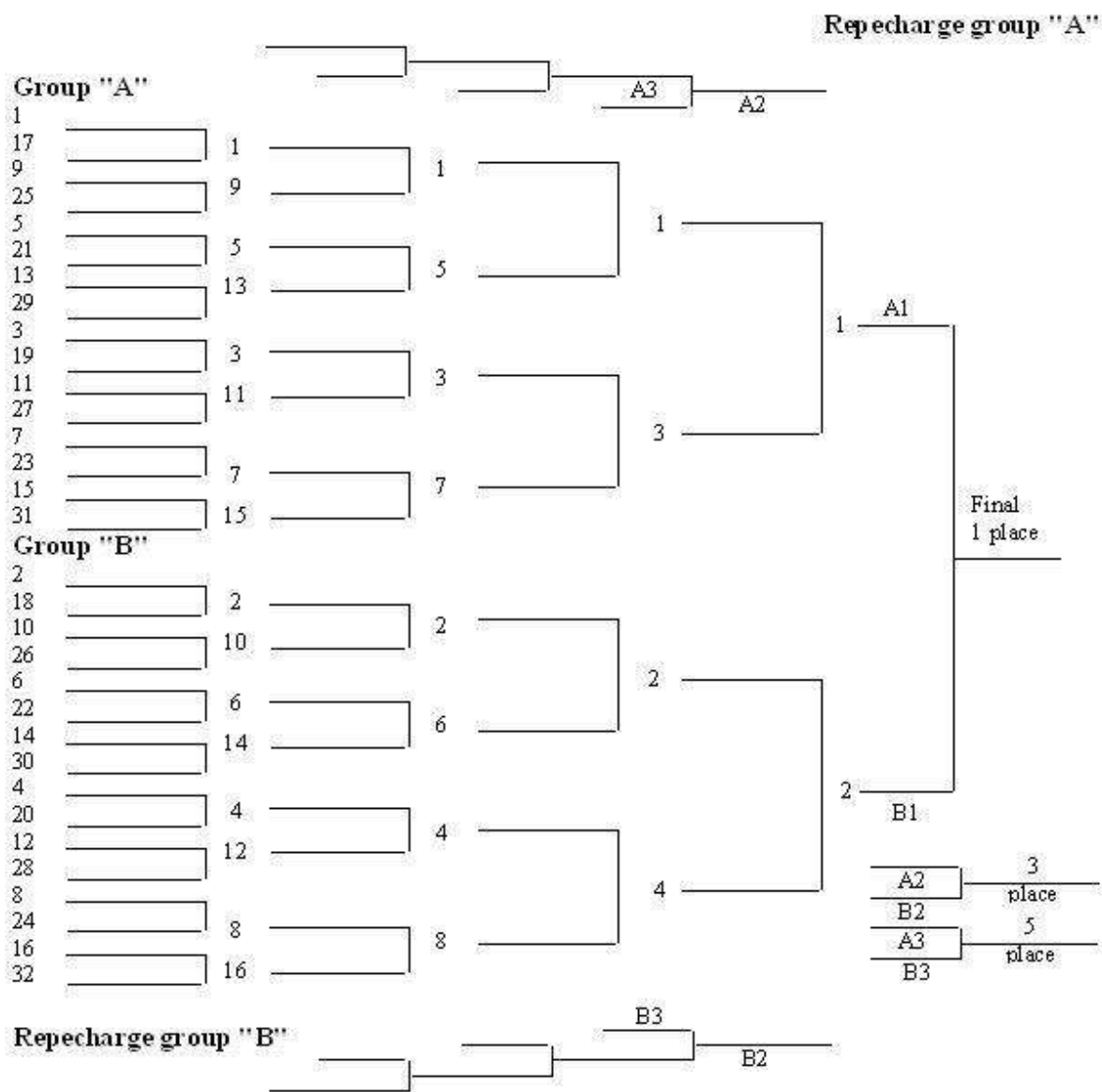

Chief Official _____ Chief Secretary _____

**Score Sheet
of Sambo Competiton Course**

« _____ » _____ 20 ____ г. City, country. _____
 Weight _____ kg

Repechage group "A"

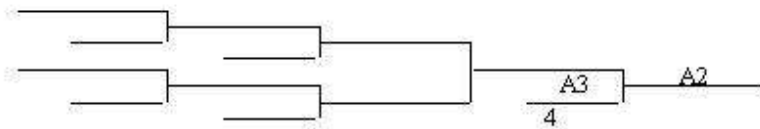

Group "A"

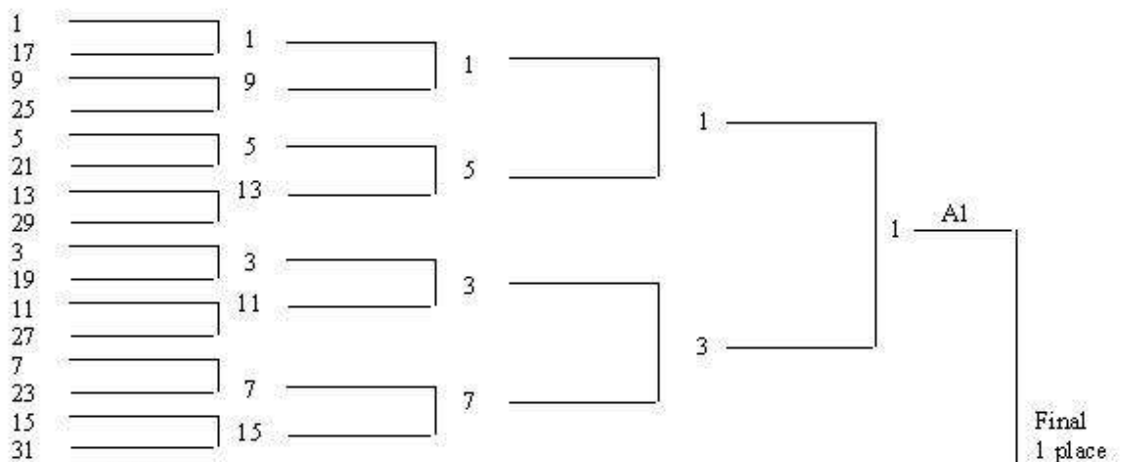

Group "B"

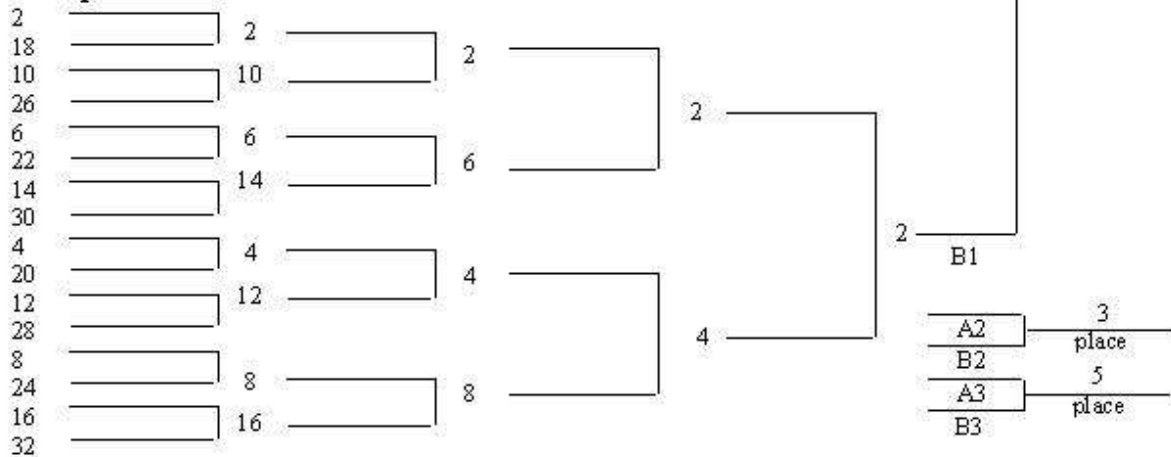

Repechage group "B"

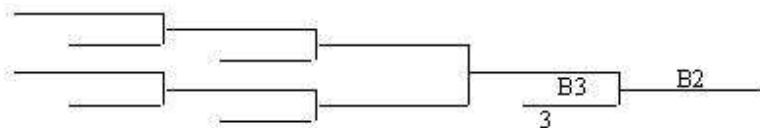

Method of Competitions in the Finals

1. Olympic method (system) of the finals for 4 contestants. The players taken the 1st and 2nd places in group A and B reach the finals: A1, A2 and B1, B2.

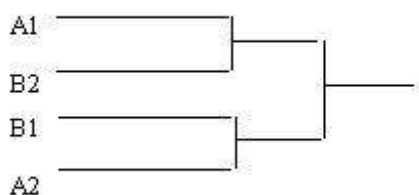

They make the semi-final pairs by the following scheme:
 The winners of semi-finals reach the finals.
 The winner of the final bout takes the 1st place, the loser - 2nd one. The losers in the semi-finals take two 3rd places.
 The 3rd and 4th places can be drawn if it is stipulated in the Regulations.

2. Olympic system to hold the finals for 8 participants. The players taken the 1st and 2nd places in groups A, B, C and D reach the finals: A1, A2 and B1, B2 and C1, C2 and D1, D2.

They make quarter-final pairs by the following scheme:

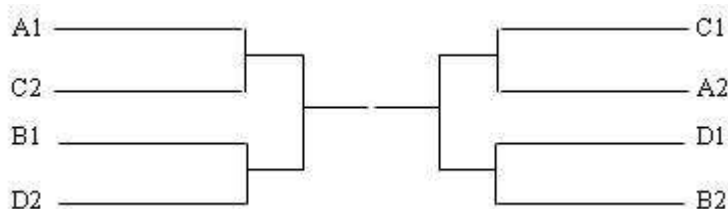

The winners in the quarter-finals reach semi-finals, the winners of the semi-finals reach the finals.
 The winner in the final bout takes the 1st place, the loser - the 2nd one. The 3rd and 4th places can be drawn if it is stipulated in the Regulations.

3. Direct method of the finals for 6 participants. The players taken the 1st - 3rd places in groups A and B reach the finals: A1, A2, A3 and B1, B2, B3.

They make the final pairs by the following scheme:

- A1-B1- for the 1st place.
- A2-B2- for the 3rd place.
- A3-B3- for the 5th place.

The winners of the finals take the 1st, 3rd and 5th places respectively, the losers - the 2nd, the 4th and the 6th ones.

4. Cross- direct method of the finals for 6 participants.

The players taken the 1st - 3rd places in groups A and B reach the finals: A1, A2, A3 and B1, B2, B3.

They make final pairs by the following scheme:

- A1 - B1 for the 1st place.
- A2 - B3 for the 3rd place.
- A3 - B2 for the 3rd place.

The winners of the final bouts take the 1st and two 3rd places respectively, the losers - the 2nd and two 5th places.

The 3rd - the 4th places can be drawn if it is stipulated in the Regulations.

I. Individual - team competitions.

1. In individual-team competitions team places are defined depending on individual placing of participants making the recorded line-up of the team. If in the Regulations some other condition is not stipulated, the team shall have one recorded participant in every weight category.

2. Team placing in individual - team competitions is defined by the one of two methods:

a) by greater sum of points scored by the recorded participants by the principle " the best is the place, the greater is number of points";

b) by the less sum of penalty points scored by all recorded participants considering the places they took by principle " the 1st place - 1 point; the 2nd place - 2 points, and so on", and for every participant absence the team is scored additional number of penalty points equal to the number of competitors in the weight category where he was absent (or in the most numerous weight category if it is stipulated in the Regulations) plus 1 penalty point.

3. With the equality of points in two or several teams, the advantage is given to the team, the participants of which have in succession:

a) greater number of the 1st, 2nd and other places that follow;

b) greater number of participants in those weight categories in which recorded participants took the first places; greater number of their victories; better quality of victories and defeats;

c) greater number of participants in the weight categories in which they took the second places, and so on.

If in a weight category only one player was weighed-in, he brings his team the points corresponding to the 1st place.

4. The results of team competitions shall be recorded in a score sheet.

II. Team competitions.

1. Team competitions may be conducted by any system used for the individual competitions. The system and method, the number of participants in the team, weight categories and the possibility of the competitors' substitution during the competitions shall be defined by the Regulations.

2. Minimum line-up of the team in every meet shall be bigger of the half of the complete team. If a contestant recorded for the meet is absent at the team presentation, the absence is scored and he is eliminated from the competitions.

3. In team competitions (see appendix 6.3) for the victory of its contestant in every pair, the team is scored 1 point, for the defeat or the absence - 0 points. In case no participant is recorded or his failure to come to the meet, his opponent is scored the victory 4:0 with the time 0.00.

The team scored the greatest number of points is the winner of the given meet.

In case of the equal number of points (the tie) the advantage goes to the team that has got:

a) greater number of positive points scored by the team participants in all the bouts of the given meet;

b) greater number of victories 4:0, including the ones with the time 0.00.

c) less time spent for these victories and further according to appendix 2.1, part III, p.4 b.

With the equality of these indices the advantage goes to the team having the greater sum of Technical points scored by all the participants in the bouts they had. Further - according to article 28, p.2. In case those indices are also equal, the team won the bout in the heaviest weight category is considered a winner.

4. The victory of the team meets as whole, scores the team 1 point, the defeat - 0 points.

5. In the competitions held by the circular method (see appendix 2.1) when placing the teams in subgroups, semifinals and finals it is successively considered:

a) the number of points for the victories in team meets;

48			1	$\frac{4:0}{2.55}$	0		
52			1	$\frac{3:1}{5.00}$	0		
56			0	$\frac{0:3}{5.00}$	1		
...							
+100			0	$\frac{0:2}{5.00}$	1		

Total result of the meets _____ in favour of the team _____

Mat chairman _____ Chief Official _____
 Referee _____ Chief Secretary _____
 Judge _____

Appendix 7

Entry

from Organization _____ for participation
 in Sambo competitions _____
 from _____ to _____ 200__ in the city of _____

No	Full name	Date of birth	Sports rating	Weight category	Organization, city, country	Place of work, studies	Coach's name	Best result	Doctor's viza. Stamp
1									
2									
3									
4									
5									
6									
7									

All in all _____ athletes are admitted to the competitions.

Chief of the Organization _____ Doctor _____
 Coach of the team _____
 Representative _____

S T A M P

Appendix 8

Score Sheet

of the weigh-in and the draw of Sambo competition participants.

" ____ " _____ 200__ City, country _____

Weight ____ kg.

No.	No. of the draw	No. of participant	Full name	Organization, city, county	Sports rating, title	Date of birth	Notes
1							
2							

3							
4							
5							
6							
7							
8							
...							

Chief Official _____
 Chief Secretary _____
 Officials _____

Doctor _____

Appendix 9

Required Number of officials and serving personnel for Sambo competition conduct (in one place)

Name of the officiating persons	Distribution of officials by the number			
	to 1 mat	to 2 mats	to 3 mats	to 4 mats
O f f i c i a l s :				
Chief Official	1	1	1	1
Chief Official's deputy	-	1	2	3
Mat chairman	2	3	5	6
Chief Secretary	1	1	1	1
Chief Secretary deputy	1	1	1	1
Secretary	-	1	3	4
Technical secretary	1	2	3	4
Timekeeper	2	3	4	5
Referee	4	8	12	16
Judge	4	8	12	16
Official attached to contestants	1	2	3	4
Informant	1	2	3	4
Commentator	1	1	2	2
S e r v i n g p e r s o n n e l				
Doctor	1	1	2	2
Medical nurse	1	2	2	3
Superintendent	1	1	1	1
Painter	1	1	2	2
Typist	1	2	3	4
Representative of the host organization	2	2	2	2
Total:	26	43	64	82

In case the competitions are held over 3 hours, additional 1 referee and 2 judges for every mat are needed.

Appendix 10

Statement of the formal acceptance of Sambo competitions venue

" ___ " _____ 200__ City, country _____

The present document is made by the Chief official, the representative of the sports facilities and the doctor verifying that the equipment of the competition venue corresponds (does not correspond) to the requirements of Sambo competitions Rules.

Explanation _____

The address of the competition venue: _____

Chief Official _____.

Representative of the sports facilities _____

Doctor _____

Appendix 11

Scheme of the Chief Official's Report Of Sambo Competitions

- 1. Organization of competitions:**
 - a) the name of the competitions;
 - b) the date of the competitions;
 - c) the city and venue of the competitions;
 - d) sports organization that was responsible for preparation and conduct of the competitions;
 - e) line-up of the Chief Officials Board;
 - f) the order of the competition conduct that was planned; its correspondence to the plan; the reasons of changes if any;
 - g) the evaluation of the competition organization (reception of participants, competition areas, meals, etc.);
 - h) the conclusions and suggestions on organization of competitions in future.
- 2. Popularization of Competitions:**
 - a) the contents and evaluation of propaganda held in connection with the competitions (posters, coverage of their course in mass media, broadcasting, information for spectators at the venue, etc.);
 - b) the number of spectators at the competitions.
- 3. Participants of the competitions (data of the Mandate Commission):**
 - a) the number of admitted participants;
 - b) the number of participants competed, including their weight category, from every sports organization;
 - c) rating qualification;
 - d) the number of participants eliminated from the competitions by the Chief official decision including the failure to appear (by default), by the doctor's decision and other reasons.
- 4. Sports evaluation of the competitions:**
 - a) conclusion of participants readiness to the competitions; characteristics of participants (teams) physical and technical preparation;
 - b) the number of participants having fulfilled sports norms (ratings) considering their victories at the given competitions.

5. Officiating:

- a) personal line-up of Officiating Board (stating the official's category of every official and his duties);
- b) evaluation of the officiating as a whole and every official personally; declaration of the best officials;
- c) number and evaluation of submitted protests,how many of them were satisfied and refused.
- c) specific suggestions on changing and more precise definition of the Rules, system and method of competitions,and so on.

6. It shall be added to the report:

- a) Regulations of the competitions;
- b) team entries for participation;
- c) materials of the Mandate Commission and participants completed forms;
- d) score sheets of the weigh-in;
- e) score sheets of the competitions course (2 copies);
- f) score sheets of the bouts and team meets;
- g) score sheets of all the meetings of the Officials Board;
- h) protests and the decisions made on them;
- i) statement of the venue formal acceptance;
- j) report of the Doctor of the competition.

Appendix 12

Officials' Gestures

R - referee, J - judge, M - mat chairman.

No	Gesture	Official making a gesture	Description of gestures
1	Introduction of participants	R	Stands facing the officials ' table and symmetrically to the players. When introducing a participant stretches in his direction the arm with the shirt sleeve of the corresponding color. Then raises his stretched arms up to the shoulder level simultaneously (edges of the palms down), each in the direction of the respective player. Brings the hands together at the shoulder level, directing to the middle of the mat and coming to that place simultaneously with the players.
2	Start of the bout	R	With the start of the bout (or its resumption from the centre of the mat) blows a whistle. Simultaneously and energetically moves his bent in the elbow arm from up to down in between the contestants, above the centre of the mat (up to the upper arm horizontal level). After that makes a step back and assumes the position suitable for watching the wrestlers' actions.
3	Total victory	R, J, M	Raises up the straight arm with the sleeve of the corresponding color, with the open palm forward.
4	4 points	R, J, M	Raises up the arm bent in the elbow, with the sleeve of the respective color, showing four fingers (the thumb is pressed to the palm) and turning the palm to the left and right.
No.	Gesture	Official making a	Description of gestures

		gesture	
5	2 points	R, J, M	Raises up the arm bent in the elbow with the sleeve of the respective color, showing the thumb and forefinger.
6	1 point	R, J, M	Lifts up the arm bent in the elbow with the sleeve of corresponding color showing the thumb only.
7	Activity	R, J, M	Raises up the arm bent in the elbow with the sleeve of the respective color. The clenched fist is turned forward.
8	Hold-down	R	At the moment the hold-down starts, simultaneously with he words:” Count the hold-down!” - stretches forward the arm palm down. The color of the sleeve corresponds to the color of the belt of the contestants applying the hold-down. If the hold-down is complete (after the words " The hold-down is scored!"), or the defensive fighter escapes (after the words " Escape!"), the referee lowers the arm and by the proper gesture shows the evaluation of the hold.
9	Painful hold (Armlock, Leglock)	R	At the moment the painful hold starts, simultaneously with the words "Count the time of the painful hold!" stretches the arm forward with the clenched fist. Oversleeve (sleeve) shall correspond to the color of the belt of the contestant applying the painful hold.
10	"Hold is not scored"	R, J	Makes 2-3 moves with his hand (open palm downwards) in horizontal plane.
11	"Off mat" position	R, J	Lifts up the straight arm nearest to the edge of the mat to the shoulder level. After that blows the whistle and shows with the straight arm to the middle of the mat. At this very moment the players shall resume the bout.
No.	Gesture	Official making a gesture	Description of gestures
12	Take up from Ground to Standing position	R, J	Blows the whistle, after that raises the arms bent in the elbows up with the open palms one to the other. In this case the forearms shall be vertical.
13	Prohibited (illegal) hold	R, J	Raises the arm up to the chest level and grips with one hand the wrist of the other, after that imitates the violation.
14	Caution	R	Facing the officials' table, puts the hand with the sleeve of the respective color on the shoulder of the player at fault and with the other hand shows the sign " caution" - the thumb and forefinger make the circle, the rest of them are straight.
15	Warning	R	Facing the officials' table and standing in the middle of the mat puts the hand with the sleeve of the corresponding color on the shoulder of the player at fault and with the other hand shows the evaluation for the warning.
16	Stop the time	R	Keeps one forearm at the face level with the horizontal open palm down and puts against the middle of that palm from downwards the fingers of the other vertical open palm with its edge forward.
17	End of the bout	R,M	Makes the oblique cross with his forearms. Both palms are with their edges forward.

18	Activize the actions	R	Rotates the forearms with the arms bent in the elbows in front of the chest.
19	Demand attention	J	Lifts up bent in the elbow arm with the open palm forward and makes 2 - 3 moves with his hand in the vertical plane.
No.	Gesture	Official making a gesture	Description of gestures
20	Demand " warning"	R, J, M	With one hand with the sleeve of the respective color shows the side of the mat assigned to the player at fault and with the other hand shows the evaluation that corresponds to the warning.
21	Contestants -to the start positions	R	Blows the whistle, after that shows with the straight arms (open palms down) the respective corner of the mat.
22	Declaring the winner	R	Stands in the middle of the mat facing the officials' table, having taken the wrists of both contestants (the color of the referee's sleeve corresponds to the color of contestants' belt). When the mat chairman declares the winner, the referee lifts his arm up. Then the referee and the contestants turn around and the referee lifts up the winners arm (the color of the sleeve does not correspond to that of the contestants belt) after that the contestants shake hands and leave the mat.
23	Declaring elimination of both contestants (0 : 0)	R	Starting position is the same. When the mat chairman declares the result of the bout, the referee holds both contestants hands but don't lift them up. The rest is the same as in declaring the winner.

1										
2										
...										

Chief Official _____ Chief Secretary _____
 Mat chairman _____ Technical secretary _____

Appendix 14

Report of the Medical service of the competitions

1. Sports event - Sambo.
 2. The name of the competitions _____.
 3. The number of days ____ from _____ to _____ 200__.
 4. Venue of the competitions _____.
 5. Full name and the title of the Chief competition doctor:
_____.
 6. Meteorological and sanitation-hygienic conditions of the competitions:
_____.
 7. The number of participants _____: male _____ female _____.
 8. The results of medical documents check _____.
 9. Brief characteristics of the venue, participants, accommodation and meals:
_____.
 10. Organization of Medical Service at the venue of competitions and participants accommodation places availability of medical first-aid posts, transport): _____.
 11. Diseases and injuries (reasons, character, the treatment rendered):
_____.
 12. The number of participants eliminated from the competitions _____ (in person) and the reasons: _____.
 13. Drawbacks in the competition conduct _____.
 14. Suggestions submitted by the doctor, their execution by the officials and team representatives _____.
- Full name, speciality, place of work of the medical personnel serving the competitions _____.
- Signature of the competition Chief doctor _____
 " ____ " _____ 200__

Appendix 15

**Score sheet
of personal results**

" ____ " _____ 200__ City, country _____
 Weight _____ kg

No.	Full name	Date of birth	Organization, city, country	Sports rating	Coach's full name	Placing	Number of points
1							
2							
3							

...							
-----	--	--	--	--	--	--	--

Note: Numerical order is general for all the participants.

Chief Official _____ Chief Secretary _____

LIST
OF THE MAIN REQUIREMENTS TO CONDUCT
NATIONAL SAMBO COMPETITIONS
(for the organizers)

1. Hotels - accommodation of participants, officials, coaches and guests.
2. Restaurant, café, canteen, buffets – for participants.
3. Transport – meeting and transportation of participants to their residence and back;
 - from the residence to the sports hall and back according to the Rules of competitions.
4. Sports hall – the act of the hall correspondence to the necessary requirements to conduct the competitions; it should be applied to the report. The hall has to be of the sufficient size to place 3 mats and also:
 - the places for the guests, leaders and press;
 - the places for spectators on the stands;
 - the places for participants;
 - the radio-equipped training hall to warm-up;
 - dress rooms for men and women with the shower and lavatory;
 - the room for the Executive Committee of the Russian Federation;
 - the room for Chief Secretaries;
 - the dress-room for the officials.

The quarters that may be foreseen in the hotel or the sports hall:

- the room to register the arriving people (leaders, officials, participants of the competitions);
- the room for the Mandate Commission;
- the room for the draw and meetings of representatives and officials;
- the room for the weigh-in.

5. MEDICAL SERVICE:

- is accomplished by the personnel of the medical-physical clinic – 1 doctor and 1 nurse for every mat;
- presence at the competitions the ambulance brigade;
- medical care is rendered on the mat and the doctors should have the replacement footwear.

6. SECURITY OF THE ORDER:

- security representatives, who submit to the Chief Official, have to be present in the sports hall.

7. EQUIPMENT:

- mats;
- electronic indicator panel to register technical actions and sanctions;
- two stop-watches for every mat;
- chairs for officials and coaches;
- 2 computers with printers;
- 2 Xeroxes;
- Electronic and mechanical scales for the weigh-in.

8. Setting of the mats, arrangement of the tables, chairs and the necessary equipment, placing of spectators, participants, officiating brigades and official persons – ACCORDING TO THE RULES OF THE COMPETITIONS.
9. Stuff to use: PAPER, FOLDERS, LOOSE-LEAF BINDERS, CLIPS, PENS AND OTHER OFFICE SUPPLIES.
10. Publicity stuff: POSTERS, PLACARDS, BOOKLETS, PROGRAMS, INVITATIONS.
11. Awarding attributes: MEDALS, CUPS, DIPLOMAS, CERTIFICATES, PRIZES FOR PARTICIPANTS, COACHES AND OFFICIALS.
12. The script of the competition Opening Ceremony.
13. The script of the Awarding Ceremony.
14. The script of the Closing Ceremony.
15. To foresee the number of officials and serving personnel according to the norms (THE NORMS ARE STATED IN THE COMPETITION RULES).
16. To foresee the officials' payment and BY THE RESULTS OF THE COMPETITIONS DEFINE 5 BEST OFFICIALS TO BE AWARDED WITH THE VALUABLE PRIZES.

REGULATIONS

OF THE INTERNATIONAL SAMBO COMPETITIONS CONDUCT UNDER THE AUSPICES OF THE INTERNATIONAL AMATEUR SAMBO FEDERATION (FIAS)

International Sambo Competitions are held under the auspices of FIAS or Continental Federations on the basis of their Regulations, FIAS decisions, Continental Federations, International Sambo Rules in accordance with the approved calendar of the competitions.

1. THE CHOICE OF THE NOMINATION (COUNTRY) TO HOLD SAMBO WORLD OR CONTINENTAL CHAMPIONSHIP.

National federations- FIAS members, which want to hold the World or Continental Sambo championship, have to submit the written request addressed to the General Secretary of the International or Continental federation not later than 2 years before the date of the competition conduct stated in the Calendar of competitions.

The requests are considered on the competitive basis. The following facts have to be stated in it:

- the name of the competitions;
- the place of its conduct (city) and approximate date;
- information of the competition place (the venue) and other necessary facilities;
- information of accommodation (conditions and prices of staying);
- information of the National federations and sponsors financial guarantee.

The requests of National federations to hold the World championship are considered at FIAS Executive Committee meeting, Continental championships - at the Continental federations Executive Committees meeting.

The final decision of the choice of the country, organizer of competitions, is taken at the Congress of the corresponding federation not later than a year before the start of the competitions.

2. RIGHTS AND DUTIES OF THE CONDUCTIVE ORGANIZATION.

The National federation, that got the right to hold the World or Continental championship on the competitive basis, must:

- form the Organizing Committee for preparation and conduct of the competitions;
- work out the detailed program of holding this sports arrangement;

- submit the financial plan with the analysis of all the expenditures necessary for holding the competitions in question.

The program of conduct and financial plan has to be submitted to the Executive Committee of the corresponding federation for the approval not later than 6 months before the start of the competitions.

All the following changes introduced by the conductive organization after the approval by the Executive Committee of the corresponding federation should be coordinated with it. President of the national federation – organizer of the competitions accounts personal responsibility to FIAS Executive Committee or Continental one for the preparation and conduct of the World or Continental championship.

The executive Committee of the International or Continental federation has the right to send the Chairman of the sports technical commission to the Organizing Committee of the competitions with the aim to render practical assistance in the preparation and conduct of the competitions.

FINANCIAL GUARANTEE

The Executive Committee of the corresponding federation takes the decision about the number of its members and the members of the officiating board the receiving side will bear the expenses for.

The expenses include:

- transportation from the place of staying to the competition venue;
- staying at the hotel not lower than 3 stars;
- three times meals;
- payment for the officials' work proceeding from: FIAS or Continental Chairman of the Referees' Commission, Chief Secretary - \$ 70 (70 Euro- ESF) per day, deputy Chief Secretary - \$ 50 (50 Euro – ESF) per day (3 persons), (the work of the Referees' Commission Chairman, Chief Official and Chief Secretary is paid for two days more).

Besides, the organizers are committed to bear expenses for the meals and accommodation of 20 officials (World and Continental championships and Cups) and pay for their work \$50 (50 Euro-ESF) per day.

The receiving organization is obliged to prepare awarding attributes for every weight category including:

the set of medals for every weight category

- 2 gold (for the champion and his coach);
- 1 silver;
- 2 bronze;
- the set of diplomas (according to the taken places);
- valuable or money prizes for the prize-winners;

In team competitions it is necessary to foresee the Cups for the 1st, 2nd, and 3rd places.

Five best officials by the results of competitions are awarded with valuable prizes.

The organizers of the competitions in their bulletins must inform in details about all expenses the National federations will bear due to their participation in the World and Continental championships.

INFORMATION AND PUBLICITY

Organizers must provide with the necessary information and program of the competitions all National federations coordinating them preliminary with FIAS Executive Committee or respectively with those of the Continental federations.

Organizers must advertise by the means of mass media (newspapers, radio, TV) the coming competitions to popularize and develop Sambo in the country playing host to the given sports event.

ACCOMMODATION

Organizers must reserve the rooms at the hotels not lower than 3 stars for the members of the National federations and to inform in time about the quality of staying there and their price. They have to provide all National federations with three meals a day. The cost of accommodation and meals for one member of the delegation should not exceed \$ 50 (50 euro –ESF) a day.

RECEPTION OF THE NATIONAL DELEGATIONS

Organizers must guarantee the free entry and departure from the country. The host country is obliged to organize offices to receive and sending off the National delegations that have to be located at the competition venue, airport and train station.

TRANSPORT

Organizers must provide with the transport to take National delegations from the airport and train station to the hotel and competition venue and during the competitions – from the hotels to the sports hall.

National federations bear expenses on transfer proceeding from \$ 10 (10 Euro-ESF) per one member of the delegation.

ACCREDITATION

Organizers have to make accreditations for all participants, officials, members of the Executive Committee, guests of honor, journalists, serving personnel and security.

3. CONDUCT OF THE COMPETITIONS.

3.1. Mandate Commission.

Organizers have to provide the Mandate Commission with the separate office.

Full power of the Mandate Commission is regulated by art. 4 of the International Sambo Rules.

The heads of the National federation delegations have to submit to the Mandate Commission the following documents:

- the team entry signed by President of the National federation to participate in the competitions (according to appendix 8 of the Rules);
- passport;
- participant's international license;
- receipt of the payment by the National federation the year member's fee;
- besides, the heads of National federations have to submit 2 national flags and the brief version of the national anthem.

3.2. Weigh-in.

Sports delegations which did not undergo the Mandate Commission are not admitted to the weigh-in.

Official weigh-in is held one day before the competitions, the order and time is stated in the Regulations.

Official weigh-in has to correspond strictly to all the requirements to art.6 of the International Sambo Rules.

In case the competitions are held during 2 days the weigh-in is held every other category, starting with the lesser one (e.g. men 52...62...74...90... +100; women 48...60...72 and so on).

If the competitions are held during 3 days, then the weigh-in is held every two categories, starting with the lesser one (e.g. men 52... 74...100; women 48...60...72 and so on).

The weigh-in is held strictly one time before the competitions of the given weight categories, no additional weigh-in on the day of the competitions is allowed.

3.3. Drawing of lots (draw).

The Chief Official of the competitions is responsible for the participants' draw.

Two variations of the draw may be held.

The first variation: the draw in all weight categories is held during the weigh-in. Every participant, after he undergoes the official weigh-in, pulls out the number according to which the place in the subgroup is defined to take part in competitions (without scattering the strongest ones).

The second variation: the draw is held on the day of arrival after the accreditation with scattering the strongest wrestlers according to preliminary entries by the computer.

3.4. Venue of the competitions.

The Chief Official must check the readiness for the competitions the facility, equipment, inventory and their correspondence to the requirements of the International Sambo Rules, to make the act of acceptance of the venue and also to assure that all the necessary documents are available.

Organizers have to foresee the following premises in the venue:

- the hall for meetings;
- the room for the work of the Executive Committee;
- the room for officials (separate ones for the Chief Official and Chief Secretary);
- dress-rooms with the keys, lavatories and showers for participants (men and women);
- the room for emergency care;
- the room for massage;
- press center with fax and telephone;
- the room for interview;
- the room for the weigh-in (men and women);
- the place for the athletes' warm-up;
- the room to rest for athletes, officials and members of the Executive Committee;
- the bar and restaurant;

Organizers must provide the venue with the corresponding inventory:

- electronic scales for the weigh-in (3);
- wrestling mats in accordance with the Sambo Rules (3);
- electronic score-board with the sound signal to inform spectators and participants about the course of the bout (3);
- stop-watches (3);
- one central table with 20 chairs for the members of the Executive Committee;
- one table with 2 chairs for the Chief Official;
- one table with 2 chairs for the Chief Secretary;
- one table with 10 chairs for the officials at every mat;
- one table at every mat for the officials attached to the participants;
- one table with 3 chairs at every mat for the medical personnel;
- one microphone on the table at every mat and one on the central table;
- one large information board to inform participants and representatives of the program, schedule and course of the competitions.

Setting of mats, arrangement of tables, chairs and the necessary equipment is accomplished according to the attached schemes.

Besides, it is necessary for the Secretariat work:

- two computers with printers;
- two Xeroxes;
- stuff to use (paper, cartridges for printers and Xeroxes, folders, loose-leaf binders, clips, pens and other office supplies).

Organizers are obliged to foresee the seats in the sports hall for participants, guests, official persons, representatives of press and TV. The entrance to the competition venue is allowed only to the people with accreditations.

3.5. COMPOSITION OF THE OFFICIATING BOARD AND SERVING PERSONNEL

The composition of the Officials' (Officiating) Board is recommended by the corresponding International federation. The work of the Board is regulated by Part 3 of the International Sambo Rules. To make the officials' work successful, the organizers must provide the Officials' Board with the serving personnel:

- courier to deliver the minutes of the competition course to the secretariat;
- courier to deliver the minutes to the central table;
- two electronic engineers to make the work of computers and the electronic board continuous;
- two persons for every mat to accompany athletes to the bout.

Superintendent of the competitions has to provide the continuous work of the serving personnel as well as the work of security.

3.6. CEREMONIAL OPENING OF THE COMPETITIONS

Organizers have to prepare the Ceremonial Opening.

Delegations of countries - participants of the competitions line up in the alphabetical order with their national flags and the tablets with the names of the countries. The team of the country playing host to the competition comes to the parade last.

The Officiating Board takes the seats in accordance with distribution to the mats opposite participants.

Under the sounds of the national anthem of the country – organizer the state flag is raised, then FIAS flag or the one of the Continental federation.

President of the country or the Chairman of the Organizing Committee welcomes all the people present at the Ceremony. Then the floor is given to FIAS or Continental federation President. President (FIAS or Continental federation) officially opens the competitions.

3.7. CONDUCT OF COMPETITIONS

The competitions are held in accordance with the Regulations of Competitions composed at the basis of the International Sambo Rules.

The competitions are held by the unified time regulations (the start of the competitions, weigh-in, Mandate Commission, Opening and Closing ceremonies, conduct of the evening part).

Mandate Commission: 11.00 – 16.00 on the day of the arrival.

Weigh-in: 18.00 – 19.00 on the day of the arrival for the participants of the first day of the competitions. 15.00 – 16.00 during the competitions.

Start of the competitions (morning part): 10.00.

Evening part of the competitions (Opening Ceremony, final bouts, awarding of champions and prize-winners, Closing Ceremony: 18.00).

During the bouts only the Officials' Board, medical personnel and the coach-second are allowed to be present at the mat. The athlete goes to the mat accompanied by a specially defined person (support personnel).

3.7. CEREMONIAL CLOSING

After the finals in every weight category all the athletes of the given category who won the prize places and their coaches, clad in the uniforms of National federations, gather in the place defined by the organizers for the awarding ceremony.

The Officiating Board takes the seats defined by the organizers (usually opposite spectators).

The announcer pronounces the last name, name, country and after that the athlete stands on the podium according to the place he took.

President of the International or Continental federation conducts the awarding.

After the awards are presented the National flags of prize-winners in the given weight category is raised and at the same time the anthem of the winner's country sounds.

At the end of the ceremony 5 best officials are awarded according to the result of the competitions.

3.8. THE CLOSING CEREMONY

The Closing Ceremony is held by the rules of the Opening Ceremony.

After the awarding in the last weight category in the presence of the officials lined up opposite participants, FIAS or Continental President declares the competitions closed. After that the National flag of the country-organizer and the flag of the International federation are pulled down, to the accompaniment of the

country - organizer anthem, FIAS or Continental federation flag is handed to the delegate of the National federation, the organizer of the next championship.

4. ORGANISATION OF THE PRESS SERVICE.

Organizers of competitions have to provide journalists and photo-reporters with the Press center. In the Press Center there should be available:

- several computers connected with Internet;
- shelves for information bulletins and protocols;
- multiplying technique (Xerox, duplicators);
- telecommunications with the minimum of devices (at the World and Continental championships for seniors – 10 devices, at the World and Continental championships for juniors and youth – 5 devices).

All journalists bear their own expenses for the use of communications means.

Organizers have to provide the Press Center with the head and the serving personnel. The head of the Press Center accomplishes the direct connection with the Secretariat of the competitions.

All radio, papers and TV journalists can receive the information only in the Press Center. The Press Center has to prepare the final documents with all the results of competitions. The schedule of the Press Center work should be convenient for all the journalists. Organizers have to provide the accredited journalists and photo reporters with accommodations.

The organization that sends journalists to the competitions should bear expenses on their travel allowance.

Contents

Part 1 Character and methods of conducting competitions	1
<u>Article 1. Character of competitions</u>	<u>1</u>
<u>Article 2. System and methods to conduct competitions</u>	<u>2</u>
Part 2 Contestants	2
<u>Article 3. Age groups</u>	<u>2</u>
<u>Article 4. Admission to the competitions</u>	<u>3</u>
<u>Article 5. Weight categories</u>	<u>4</u>
<u>Article 6. Weigh-in</u>	<u>4</u>
<u>Article 7. Competitors' duties and rights</u>	<u>5</u>
<u>Article 8. Dress</u>	<u>6</u>
<u>Article 9. Team representatives, coaches and team captains</u>	<u>7</u>
Part 3 Officials	8
<u>Article 10. Composition of the Officiating Board</u>	<u>8</u>
<u>Article 11. The Chief Official</u>	<u>9</u>

<u>Article 12. The Chief Secretary</u>	<u>11</u>
<u>Article 13. The mat chairman</u>	<u>11</u>
<u>Article 14. The referee</u>	<u>12</u>
<u>Article 15. The judge</u>	<u>14</u>
<u>Article 16. The timekeeper</u>	<u>15</u>
<u>Article 17. The technical secretary, informant, commentator</u>	<u>15</u>
<u>Article 18. The official attached to contestants</u>	<u>17</u>
<u>Article 19. The doctor of the competitions</u>	<u>18</u>
<u>Article 20. Superintendent of the competitions</u>	<u>18</u>

Part 4 The Rules of Officiating	19
<u>Article 21. The contents of Sambo contest</u>	<u>19</u>
<u>Article 22. Start and end of the bout</u>	<u>22</u>
<u>Article 23. Course and duration of the bout</u>	<u>23</u>
<u>Article 24. The number of the bouts</u>	<u>23</u>
<u>Article 25. The outcome and evaluation of the bout</u>	<u>24</u>
<u>Article 26. Total victory</u>	<u>25</u>
<u>Article 27. Victory by Superiority and on Points</u>	<u>26</u>
<u>Article 28. Technical victory</u>	<u>27</u>
<u>Article 29. Victory on Warnings</u>	<u>27</u>
<u>Article 30. Elimination and disqualification</u>	<u>28</u>
<u>Article 31. Evaluation of holds</u>	<u>29</u>
<u>Article 32. Stalling (passivity)</u>	<u>31</u>
<u>Article 33. Fight near the limits of the mat</u>	<u>32</u>
<u>Article 34. Prohibitions and illegal holds</u>	<u>32</u>
<u>Article 35. Cautions and warnings</u>	<u>33</u>
<u>Article 36. Definition and declaration of the bout results</u>	<u>34</u>
<u>Article 37. Protests</u>	<u>35</u>

Part 5. Equipment of the Competition Area	37
<u>Article 38. The mat</u>	<u>37</u>
<u>Article 39. Special equipment and inventory outfit</u>	<u>38</u>
<u>Article 40. Requirements on the competition venue</u>	<u>39</u>

Part 6. Combat Sambo

Article 41. Evaluation of the bout and technical actions	
Article 42. Permitted (legal) technical actions	
Article 43. Illegal (prohibited) technical actions	

Appendixes 1-14





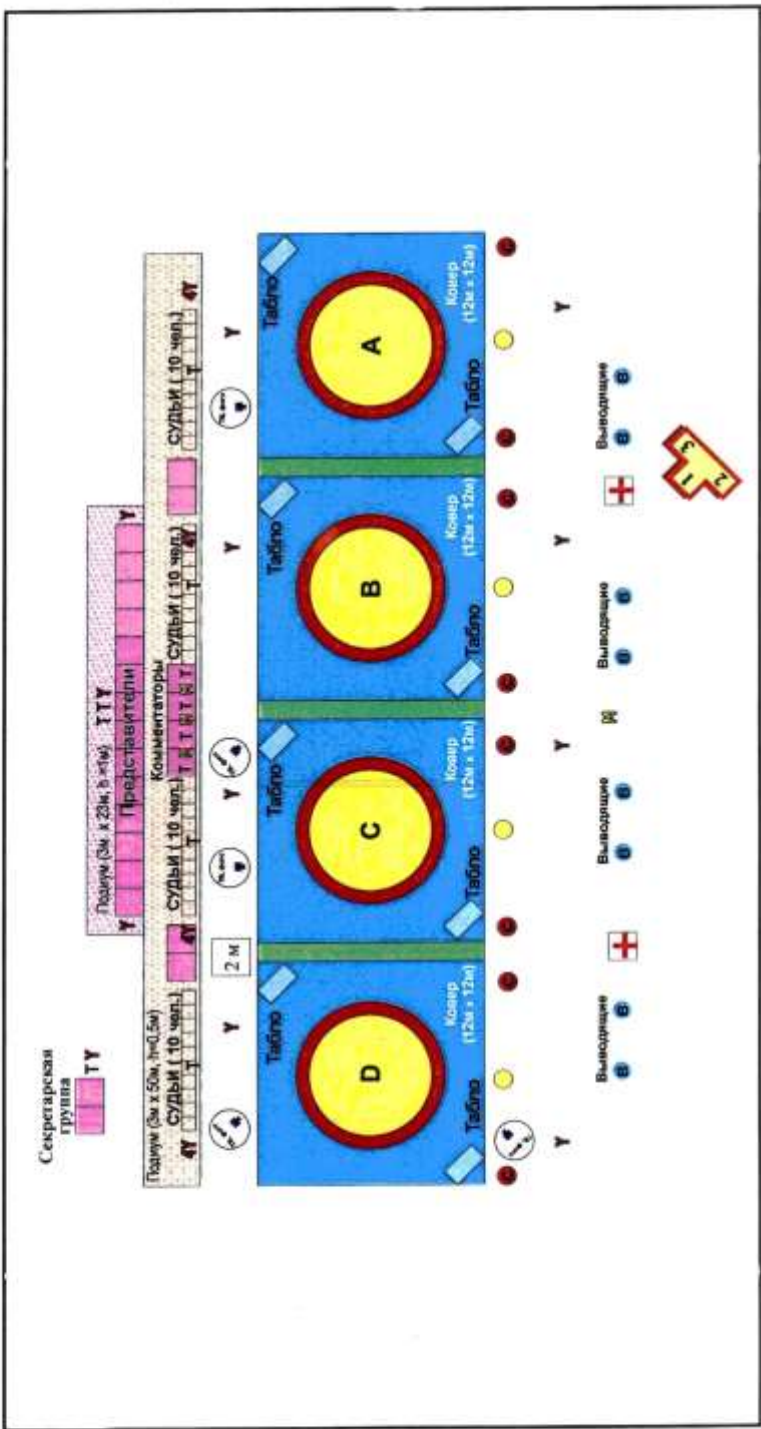

List of the Main Requirements to Conduct Sambo Competitions (for organizers)

Regulations of the International Sambo Competitions Conduct Under the Auspices of the International Amateur Sambo Federation (FIAS)

Variation of the Competition Venue Decoration



УСЛОВНЫЕ ОБОЗНАЧЕНИЯ

-  - стол со стулом (1.5м * 1.5м)
-  - стул (1м * 1м)
-  - место судьи на ковре (стул 1м * 1м)
-  - место для тренера (стул 1м * 1м)
-  - места для врачей (стол со стулом 1.5м * 1.5м)
-  - места для врачей команды (стул 1м * 1м)
-  - табло на ковре (2м * 1м)
-  Т - телефон
-  У - эл. розетка
-  М - микрофон

-  Выпорецкие
-  Выпорецкие
-  Выпорецкие
-  Выпорецкие
-  Выпорецкие